

# Synthetic Aperture Radar using Emitters of Opportunity

Piotr Serafin, Adam Kawalec, Czesław Leśnik, Michał Pyć, and Jerzy Pietrasinski

**Abstract**—The capability of a radar imaging system to stay undetected while gathering data is one of the most desired for military reconnaissance systems. This is particularly difficult to achieve for synthetic aperture radar (SAR), that have to emit electromagnetic energy all the time during the operation and to move along a strictly defined route. Therefore the idea of a passive imaging system although encountering many constraints seems to be very interesting.

The possibilities of a passive synthetic aperture radar system working with different types of emitters of opportunity are described in the paper. Impact of signal characteristics on image quality and geometry issues are discussed among others. Results of computer simulations of such a system implementing different imaging algorithms as well as the results of the experiment performed with passive SAR system model are presented.

**Keywords**—Synthetic aperture radar (SAR), passive SAR.

## I. INTRODUCTION

SYNTHETIC APERTURE RADAR as an imaging technique has gained a high popularity. Yet in order to achieve high resolution of the acquired image the radar has to move without making unexpected maneuvers and emit sounding signals through the observation time which makes it vulnerable to anti-aircraft defense.

For some years an idea of imaging system operating without a transmitter have become more and more popular in the literature [1]. Such a system would receive signals emitted by transmitters present (or located) near the imaged area, however it would not be necessary to use the transmitter that is controlled by the system. Such occasional sources of sounding signals are called the emitters of opportunity.

Thanks to its bistatic geometry passive radar enjoys several benefits that are unreachable for the monostatic solution such as [2] the better immunity to the ECM (Electronic Counter Measure) as well as ECCM (Electronic Counter Counter Measure) and, in some cases, better scattering conditions.

## II. THE SYSTEM GEOMETRY

A passive imaging radar system that uses external sounding signals has bistatic geometry, which means that the range is in fact the bistatic range being the sum of the transmitter-target and the target-receiver distances. The iso-range surfaces

P. Serafin, A. Kawalec, C. Leśnik, and J. Pietrasinski are with Military University of Technology, Gen. Sylwestra Kaliskiego 2, 00-908 Warsaw, Poland (e-mails: {piotr.serafin; adam.kawalec; jerzy.pietrasinski; czeslaw.lesnik}@wat.edu.pl).

M. Pyć is with Polish Air Force Academy, Dywizjonu 303, 08-521 Dęblin, Poland (e-mail: mpyc@wp.pl).

in bistatic radar systems are ellipsoids with the transmitter and the receiver located in its foci. This rule applies to passive SAR systems as well.

There are many descriptions of bistatic SAR (BiSAR) systems in the literature [3] and there are three main configurations of such a system [1] [3] [4] [5]. These are as follows: moving receiver – stationary transmitter, stationary receiver – moving transmitter, moving both: receiver and transmitter. In this paper only a moving receiver – stationary transmitter configuration where the transmitter is non-cooperating one is considered.

Let us assume a receiver mounted aboard of an airplane (carrier) that is flying along a straight route, at a constant altitude, with a constant velocity. The transmitter is non-moving (stationary), installed at a lower height than the altitude of the carrier. A general geometry for the discussed configuration case is shown in Fig. 1. Figure 2 shows different geometries where the position of the transmitter in reference to the receiver path and the observed surface creates different alignment of the iso-range ellipsoids.

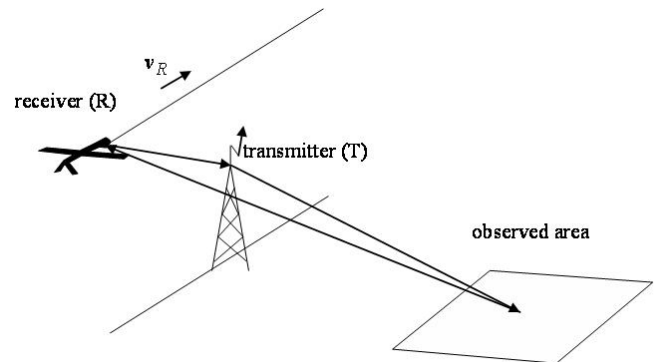

Fig. 1. General geometry of a passive SAR system.

The receiver has two antenna channels: one for direct transmitted signal reception, second for reception of the signals reflected from the observed surface.

The direct channel antenna has to have a relatively narrow beam and it should be following the position of the transmitter, whereas the reflected signal channel (the main channel) antenna should have a beam of a width appropriate to the desired synthetic aperture length.

One can assume a Cartesian coordinate system, and that the trajectory of the receiver is lying in the plane. Then one can

denote the bistatic range between the transmitter, the target and the receiver as

$$R_{TCR}(\tau) = \sqrt{(x_T - x_C)^2 + (y_T - y_C)^2 + (z_T - z_C)^2} + \sqrt{x_C^2 + (y_C - y_{R0} - \nu_{RT}\tau)^2 + (z_C - h_R)^2} \quad (1)$$

where  $\tau$  is the time associated with the receiver movement also referred to as the slow time.

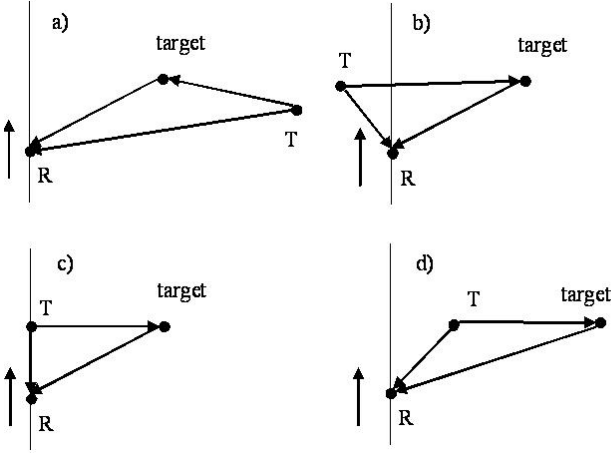

Fig. 2. Different geometry cases of a passive SAR system.

The above expression can be simplified by the assumption that the observed targets are on the ground level. As a result one can write a formula as follows

$$R_{TCR}(\tau) = \sqrt{(x_T - x_C)^2 + (y_T - y_C)^2 + z_T^2} + \sqrt{x_C^2 + (y_C - y_{R0} - \nu_{RT}\tau)^2 + h_R^2} \quad (2)$$

Due to the receiver movement the bistatic base of the system (i.e. the direct distance between the transmitter and the receiver) changes accordingly to the following formula

$$R_{TR}(\tau) = \sqrt{x_T^2 + (y_T - y_{R0} - \nu_{RT}\tau)^2 + (z_T - h_R)^2} \quad (3)$$

The geometry of the system has a great influence on the image resolution and ambiguity. As it was mentioned above the bistatic iso-range surfaces are ellipsoids and size of the iso-range resolution cell is dependent on the position of the observed point on those surfaces. It means that for passive synthetic aperture radar the resolution cell size changes with every position of the receiver. The cuts of the iso-range ellipsoids with the earth surface are ellipses and the targets lying on those ellipses can be resolved either by the real antenna beam or synthesizing the synthetic aperture image.

The azimuth resolution in synthetic aperture radar is associated with the range changes rate. If the iso-range rate (also referred to as iso-Doppler) lines are not parallel to the iso-range ones the targets can be resolved one from the other otherwise the image will be ambiguous.

### III. SIGNAL MODEL

If one denotes the transmitted signal as  $s(t)$ , then in the case of a single point-like reflecting object existing in the observed

area, the signals received in the main ( $s_M(t)$ ) and the auxiliary ( $s_{Aux}(t)$ ) channel can be denoted respectively as:

$$s_M(t, \tau) = s\left(t - \frac{2R_{TCR}(\tau)}{c}\right) \exp\left(-j\frac{2\pi}{\lambda}R_{TCR}(\tau)\right) \quad (4)$$

and

$$s_{Aux}(t, \tau) = s\left(t - \frac{2R_{TR}(\tau)}{c}\right) \exp\left(-j\frac{2\pi}{\lambda}R_{TR}(\tau)\right) \quad (5)$$

where  $\lambda$  is the wavelength and  $c$  is electromagnetic wave propagation speed.

In order to determine the difference of the time of arrival to the receiver of those two signals, one must calculate their cross-correlation function for each receiver position

$$\varphi_{xy}(\xi, \tau) = \int s_M(\xi, \tau) s_{Aux}^*(t - \xi, \tau) dt \quad (6)$$

where  $*$  denotes complex conjugate and  $\xi$  is the time shift associated with bistatic range.

The width of the cross-correlation function as well as the range resolution of the image are dependent on the transmitted signal spectrum width. The wider spectrum the narrower the cross-correlation function and the better resolution can be achieved. Therefore the type of the emitter affects the passive SAR system performance. While in urban areas there is a wide variety of signal sources to choose from (analogue and digital TV, FM radio transmitters, GSM stations), in uninhabited areas the set of emitters can be scarce and the user of the system will have to agree for worsening the image parameters.

The cross-correlation calculation procedure acts as the range compression and the set of signal vectors received in successive receiver positions constitutes the passive SAR raw signal.

It can be shown that the position of the maximum of the cross-correlation function depends on the differential range defined as

$$R_D(\tau) = R_{TCR}(\tau) - R_{TR}(\tau) \quad (7)$$

and that its phase is proportional to  $R_D$ . Therefore if there is only the echo from the single point-like object present in the received signal, one can write

$$\varphi_{xy}(\xi, \tau) = \varphi_{xx}\left(\xi, \tau - \frac{R_D(\tau)}{c}\right) \exp\left(j\frac{2\pi}{\lambda}R_D(\tau)\right) \quad (8)$$

where  $\varphi_{xx}$  is the autocorrelation function of the transmitted signal  $s(t)$ .

### IV. IMAGE SYNTHESIS ALGORITHM

The passive SAR image synthesis algorithm, similarly to the active one, bases on a coherent summing of the echo signals along the range curve  $R_{TCR}(\tau)$ , describing the changes of the propagation distance from the transmitter, through the target to the receiver. The knowledge of the signal range history is essential when synthesizing the image. Firstly one has to compensate for the migration of the cross-correlation function maximum (range migration – RM) and collect the signals along the curve defined by (7). In the next step the phase

compensation is needed by exponential term from (8). Thus the image synthesis algorithm can be described as follows

$$I(y, R) = \int_{y-L/2}^{y+L/2} \varphi_{xy}(\xi - \frac{R_D(\tau)}{c}, \psi) \exp(-j \frac{2\pi}{\lambda} R_D) d\psi \quad (9)$$

where  $\psi$  is the position of receiver along the synthetic aperture during the synthesis of an image point  $(y, R)$ ,  $L$  is the length of the aperture to be synthesized.

The algorithm described above is analogous to the Time Domain Correlation Algorithm (TDC) [6] known from monostatic SAR. Its results are very accurate, but it is also very computationally demanding.

Another SAR image synthesis algorithm that is more popular is the range-Doppler algorithm (RDA). It comprises of the two dimensional Fourier Transform in the range and azimuth domains, then range migration compensation and phase compensation. Due to the application of the Fast Fourier Transform this algorithm can be much faster than the previous one, but in order to reduce residual phase errors a procedure of additional compensation for range image spreading (Secondary Range Compression – SRC) is needed.

## V. SIMULATION RESULTS

In order to verify the theoretical assumptions a computer simulation of a moving receiver – stationary transmitter passive SAR system was implemented.

An emitter of opportunity was assumed to illuminate the area with a signal having the central =100 MHz with a bandwidth of  $B=20$  MHz. The geometry of the system was similar to the one showed in Fig. 2d), i.e. the receiver observed the target area over the transmitters shoulder. Table 1 presents the simulation parameters.

TABLE I  
PASSIVE SAR COMPUTER SIMULATION PARAMETERS

Parameter	Value
centre frequency	100 Mhz
signal bandwidth	20 Mhz
platform velocity	150 m/s
platform height	300 m
synthetic aperture length	400 m

Beneath the simulation results are presented for a sets of discrete point-like reflectors distributed in the way showed in Fig. 3.

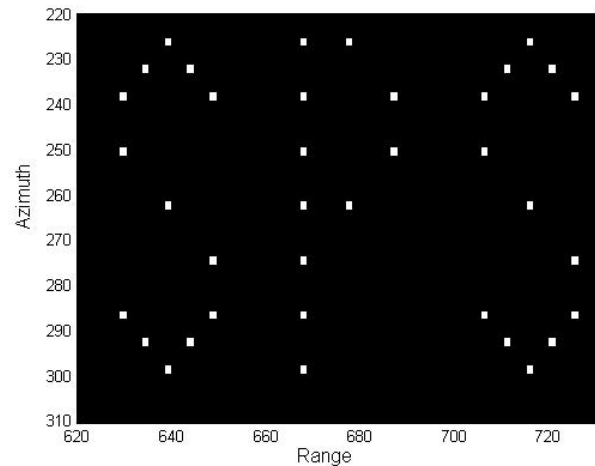

Fig. 3. Distribution of reflecting objects for the computer simulation.

Figure 4 presents the raw signal after the cross-correlation (range compression) procedure.

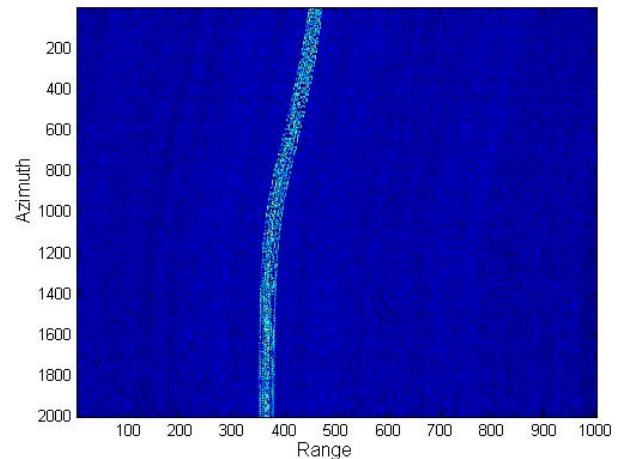

Fig. 4. Passive SAR raw signal.

Figure 5 compares the azimuthally compressed SAR images obtained by the TDC algorithm and RDA algorithm without the SRC procedure. Range spread of target images can be observed in the latter.

## VI. THE EXPERIMENT

In this section the results of the experimental verification of the above theoretical considerations are presented.

For the experiment purposes a passive synthetic aperture radar system model has been built. It consisted of the Agilent E 4433 B RF generator, and a coherent two-channel RF receiver based on the National Instruments PXI-e universal platform.

The receiver consisted of two PXI5601 quadrature demodulators and two PXI5622 digitizers along with a PXI5652 RF generator serving as a local oscillator. The block diagram of the receiver is presented in Fig. 6.

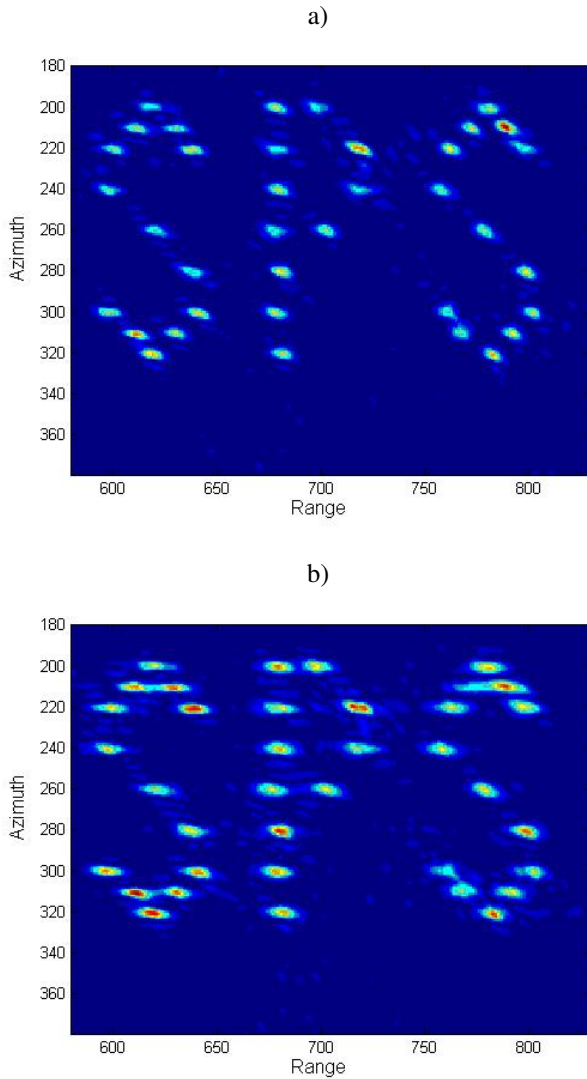

Fig. 5. Computer simulation results for a) TDC and b) RDA imaging algorithms.

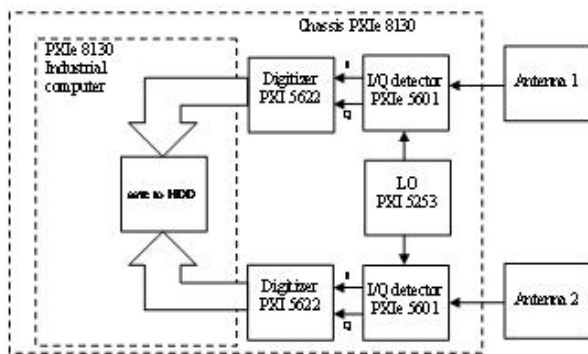

Fig. 6. Experiment organizational scheme.

The transmitter and the receiver were positioned at separate locations. The antenna of the transmitter was illuminating the observed scene. One of the receiver antennae (auxiliary channel) was facing the transmitter, while the other (main channel) received echo signal from the scene. The organizational scheme for the experiment is presented in Fig. 7.

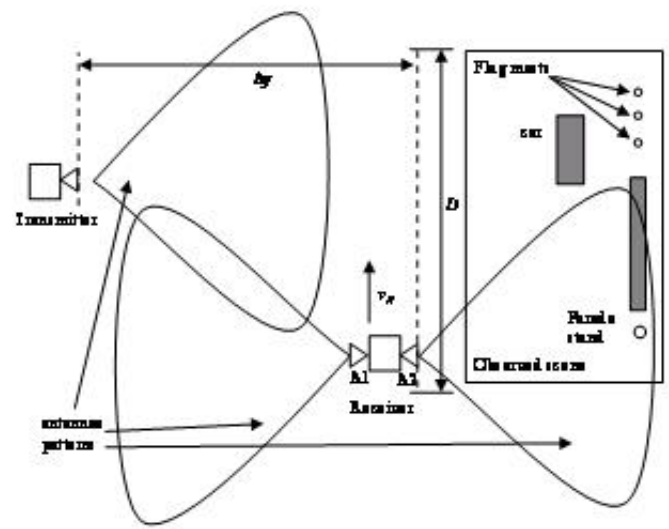

Fig. 7. Experiment organizational scheme.

The receiver was moving along a straight line and at subsequent positions it recorded signals of relatively long duration of 200  $\mu$ s. This means that for the purpose of the signal analysis the modeled system can be considered to be a bistatic continuous wave radar.

The parameters of the experimental system model are presented in Tab. 2.

TABLE II  
PARAMETERS OF THE EXPERIMENTAL SYSTEM MODEL

Parameter	Value
carrier frequency	$f_0 = 1.2$ GHz
signal bandwidth	$B = 20$ MHz
single observation period	$T = 200$ $\mu$ s
sampling frequency	$f_{prob} = 50$ MHz
distance between receiver positions	$d = 0.3$ m
observation distance	$L = 30$ m
transmitter displacement	$\Delta y = 30$ m

The signals received in the two channels, after the conversion to the baseband were digitized and in a form of complex vectors recorded on a hard disc by an application implemented in an embedded PXI computer.

The next step of the signal processing was the computation of the cross-correlation function between the signals from the main and the auxiliary channel according to (6), which played the role of the range compression step. Figure 8a shows the example of the real part of the raw, non-compressed signal from both channels, while Fig. 8b presents the magnitude of the cross-correlation function of those signals.

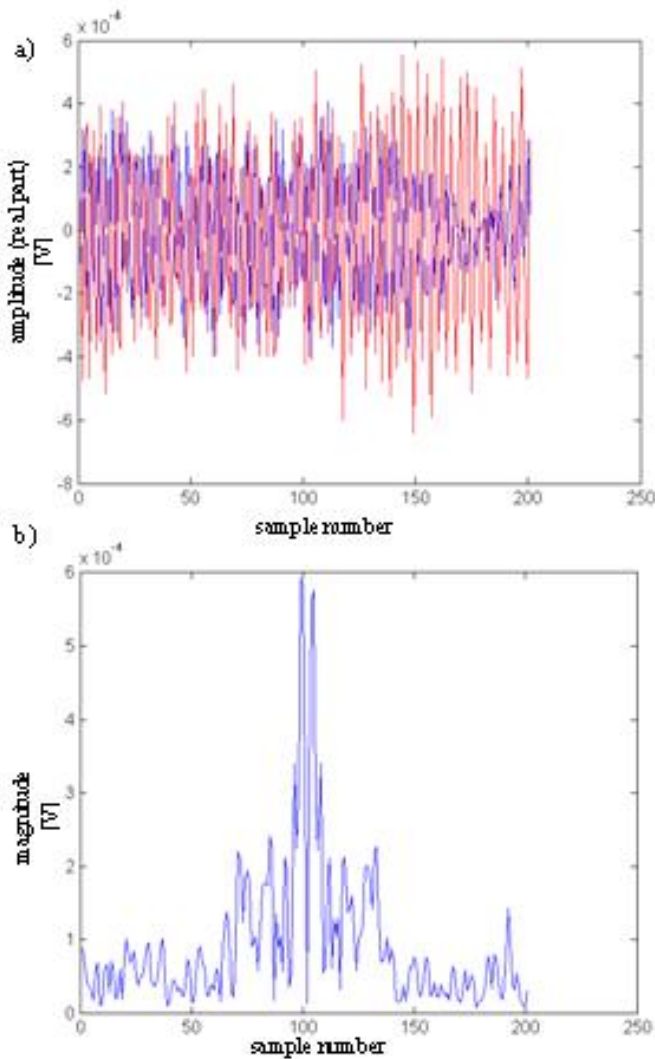

Fig. 8. Non-compressed raw signals and their cross-correlation function.

After such processing the resulting signal was combined into a matrix of a raw, range-compressed SAR signal (Fig. 9) consisting of subsequent range lines (cross-correlation functions).

Then the raw signal was compressed in the azimuth domain using the TDC algorithm described by (9). The synthesized passive SAR image is presented in Fig. 10.

During the experiment the observed scene contained the stand at the parade ground at the Military University of Technology and a car standing next to it. The objects stand was positioned approximately 50 m and the car about 35 m from the receiver trajectory.

Due to a relatively low probing frequency of the receiver and even lower transmitted signal bandwidth, the range resolution of the resulting image was approximately 15 m, which did not allow to acquire accurate images of the car and the parade stand. It is possible, however, to distinguish the flag mast poles standing behind the car.

## VII. CONCLUSIONS

This paper presents the possibility of image synthesis from passive synthetic aperture radar system working with non-

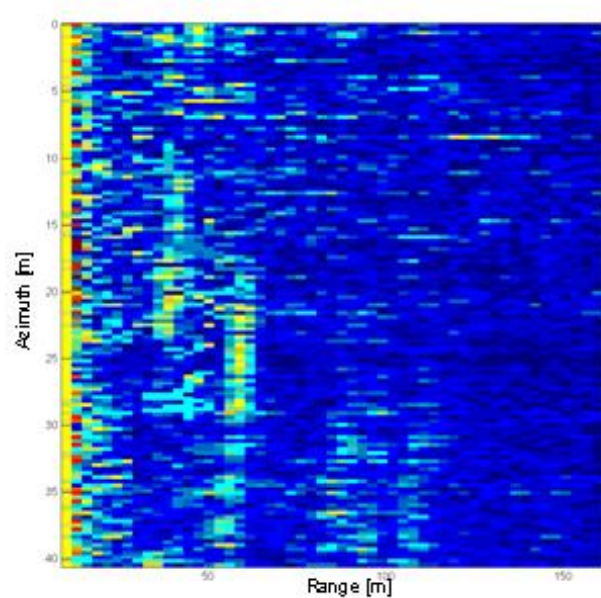

Fig. 9. Range compressed raw signal.

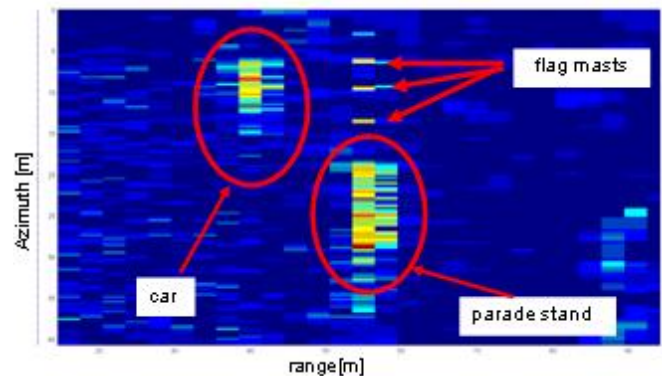

Fig. 10. Passive SAR image of the parade ground.

cooperative transmitters (emitters of opportunity). The geometry of such a system is analyzed and signal model as well as signal processing algorithm are presented. A computer simulation results of a passive SAR system are presented. Based on theoretical considerations the experimental measurements were performed. A laboratory model of a passive synthetic aperture radar with a non-cooperative transmitter was built and the results of the experiment are presented.

## REFERENCES

- [1] C. Prati, F. Rocca, D. Giancola, and A. M. Guarnieri, "Passive Geosynchronous SAR System Reusing Backscattered Digital Audio Broadcasting Signals," *IEEE Transactions on Geoscience and Remote Sensing*, vol. 36, no. 6, pp. 1973–1975, 1998.
- [2] H. Griffiths, "Passive Bistatic Radar," *RTO Educational Notes -Lecture Series RTO-EN-SET-133 Waveform Diversity for Advanced Radar Systems*, Brno, 2009.
- [3] R. Wang, O. Loffeld, Y. L. Neo, H. Nies, I. Walterscheid, T. Espeter, J. Klare, and J. Ender, "Focusing Bistatic SAR Data in Airborne/Stationary Configuration," *IEEE Transactions on Geoscience and Remote Sensing*, vol. 48, pp. 451–465, 2010.

- [4] O. Loffeld, H. Nies, V. Peters, and S. Knedlik, "Models and Useful Relations for Bistatic SAR Processing," *IEEE Transactions on Geoscience and Remote Sensing*, vol. 42, no. 10, pp. 2031–2038, October 2004.
- [5] H. Wuming and W. Jun, "Airborne SAR passive radar imaging algorithm based on external illuminator," *1st Asian and Pacific Conference on Synthetic Aperture Radar*, pp. 642–645, 2007.
- [6] L. Rosenberg and D. Gray, "Multichannel SAR imaging with back-projection," *Proceedings of the Intelligent Sensors, Sensor Networks and Information Processing Conference*, pp. 265–270, 2004.