

ANALYTICAL SYNTHESIS OF PARAMETER-VARYING FILTER OF CONSTANT COMPONENT WITH APPLICATION TO SWITCHING SYSTEMS

Jacek Piskorowski, Roman Kaszyński

West Pomeranian University of Technology, Department of Electrical Engineering, Gen. Sikorskiego 37, 70-313 Szczecin, Poland
(✉jacek.piskorowski@zut.edu.pl, +48 91 449 5235, roman.kaszyński@zut.edu.pl)

Abstract

In this paper, we propose a concept of a continuous-time filter of constant component that exhibits a very short response in the time domain if compared to the traditional time-invariant filter. The improvement of the filter dynamics was achieved as a result of the time-varying parameters which were introduced to the filter structure. Such a designed filter is then applied in a system which switches many distorted signals which should be filtered as fast as possible. The paper is of review nature and presents both a theoretical background of the proposed filter and the results of simulations.

Keywords: data acquisition, analog signal processing, transient behavior, dynamics, switching systems, linear parameter-varying technique (LPV), linear time-varying systems (LTV).

© 2011 Polish Academy of Sciences. All rights reserved

1. Introduction

In many measurement processes there is a need for filtering in signal acquisition systems. One of the main aims of the filtering is to work out a constant component of an input signal as fast as possible [1]. This requirement is related to the improvement of filter properties in the time domain. The acquisition of a large number of data, resulting from measurements carried out on a large number of signals, often requires a process of multiplexing. These signals are often distorted by noise, which causes considerable reduction of the usefulness of the instantaneous values of registered signals. The commonly used smoothing filters are, in many cases, insufficient due to the long-lasting transients.

The improvement of the transient behavior of a system for a given set of operating conditions is an old problem which has been considered in many fields of engineering. There is a plethora of techniques used for this aim in adaptive and control systems. In the field of circuit design, there are many situations in which the transient behavior of a given system must be minimized as much as possible. Operational amplifiers used in switched-capacitor circuits are the best example of these systems. There are several techniques proposed in the literature for the design of these circuit blocks which take in account the adjustment of the settling time within a given boundary (see, for instance, [2-5]).

For traditional time-invariant filters there are only small possibilities of shortening the transient state, since the filter parameters are calculated on the basis of the assumed approximation method of the frequency characteristics. This guarantees that the frequency requirements are satisfied without taking into consideration the character of the transient state. If the requirements on the frequency characteristics are imposed, we can slightly influence on the reduction of the transient state of the n -th order filter by choosing different methods of the approximation. However, there is another possibility to solve the problem previously described. It is possible to attain a significant reduction in the duration of the transient

behavior of a lowpass filter or a filter of constant component to a given input signal by varying its filter passband. The variations of the filter passband are achieved by varying the value of the filter coefficients during the time interval where the transient behavior is expected to occur.

In this paper, a review of a mathematical description and results of simulations of a continuous-time parameter-varying filter of constant component with application to switching systems is presented. This review is supplemented with an analysis of the proposed filter based on product systems that exhibit a dead-zone nonlinearity effect. The strategy proposed for the variation of parameters was used in the past with some modifications in a number of applications. For instance, in [6, 7], a parameter-varying lowpass filter was used to eliminate the oscillatory response exhibited by load cells used in weighting applications. Another parameter-varying filter was used in [8, 9] to reduce the time employed in the acquisition of evoked potentials generated through auditory stimuli. Moreover, the parameter-varying technique was used to reduce the transients of delay-equalized lowpass filters [10-13] and analog and digital notch filters [14, 15].

The rest of this paper is organized as follows: in Section 2 the transients in filters with time-varying parameters are discussed. Section 3 analyzes a class of filters of constant component. The technique used to vary the parameters of a prototype linear time-invariant filter of constant component as well as the properties of the resulting filtering system will be presented in Section 4. Section 5 then presents the results of simulations of the time-varying filtering in the signals multiplexing system. The conclusions are presented in Section 6. The paper is of review nature. Some parts of this paper can be found in [8, 10, 16-19].

2. Transients in Filters with Varying Parameters

The simplest system which can act as a lowpass filter or a constant component filter is the first-order time-lag system which may be described by the following differential equation:

$$T(t)y'(t) + y(t) = x(t), \quad (1)$$

where: $x(t)$ and $y(t)$ are respectively the input and output of the filter and $T(t)$ is a time-varying function of time constant T . In order to examine the properties of the time-varying filter let us assume the following form of function $T(t)$ [8]

$$T(t) = T(1 - c \cdot e^{-tT^{-1}}), \quad (2)$$

where: c is a constant which describes the variation range of the function $T(t)$. Comparing the step response $h_v(t)$ of the filter with varying parameter with the step response $h_c(t)$ of the corresponding filter with constant parameter ($T = \text{const}$)

$$h_v(t) = \frac{e^{tT^{-1}} - 1}{e^{tT^{-1}} - c}, \quad h_c(t) = 1 - e^{-tT^{-1}} \quad (3)$$

and then comparing the response $\tilde{y}_v(t)$ of the system with varying parameter to the sine signal $x(t) = 1(t) \cdot \sin(\omega t + \varphi)$

$$\tilde{y}_v(t) = \frac{e^{tT^{-1}} [\sin(\omega t + \varphi) - \omega T \cos(\omega t + \varphi)] + \omega T \cos \varphi - \sin \varphi}{(1 + \omega^2 T^2)(e^{tT^{-1}} - c)} \quad (4)$$

with the response $\tilde{y}_c(t)$ of the system with constant parameter to the same excitation

$$\tilde{y}_c(t) = \frac{e^{-tT^{-1}} (\omega T \cos \varphi - \sin \varphi) + \sin(\omega t + \varphi) - \omega T \cos(\omega t + \varphi)}{1 + \omega^2 T^2}, \quad (5)$$

one obtains

$$\frac{h_v(t)}{h_c(t)} = \frac{\tilde{y}_v(t)}{\tilde{y}_c(t)} = \frac{1}{1 - c \cdot e^{-tT^{-1}}} = \chi(tT^{-1}, c). \quad (6)$$

From the comparison of the responses to the sinusoidal input one gets the same function (6) as from the comparison of the step responses. To illustrate relation (6) one has plotted function $\chi(tT^{-1}, c)$ in Fig. 1.

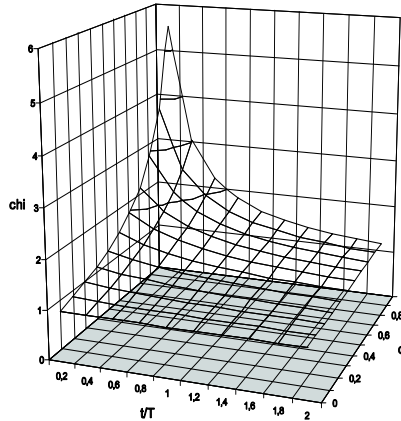

Fig. 1. Function $\chi(tT^{-1}, c)$ from relation (6).

One can see that the surface of function $\chi(tT^{-1}, c)$ in the whole range of variables t and c lies above the plane $\chi = 1$. Only for $c = 0$ the function $\chi(tT^{-1}, 0) = 1$. This is obvious since for $c = 0$ the time function described by (6) becomes a time constant independent of time. Values of function $\chi(tT^{-1}, c)$ in the rest of the range of the variables rise with an increase of the range of changes of the time function ($c \rightarrow 1$). It can be also seen that with the increase of time the value of the function tends asymptotically to unity, independently of the values of the variable c . It means that in the steady state the time-invariant and time-varying systems, which are corresponding to each other, have the same responses to the same input signals. The step response of the system with varying parameters has a shorter settling time (measured with α -accuracy) than the analogous system with constant parameters. Settling time is the elapsed time from input application until the output arrives at and remains within a specified error band α around the final value.

Considering the system with varying parameters as a low-pass filter, one can notice that values of function $\chi(tT^{-1}, c)$ greater than one result in a longer damping time of the components with frequencies $\omega > 0$. This means that the harmonic components will be damped longer in the parametric system than in the system with constant parameters. However, it is known from the analysis of systems with constant parameters that damping of the harmonic components with α -accuracy is many times shorter than working out the constant component. One should then estimate whether the introduction of the time-varying parameters can shorten the transient of the filter [8].

The analysis of the transient response of the time-varying filter has been carried out for the first-order system only. For higher-order filters the closed form solutions of time-varying differential equations are usually unavailable, so such an analysis is practically impossible. However, a series of numerical analyses proved that the conclusions arisen from the analysis of the first-order time-varying system may be extended for higher-order time-varying filters.

3. Filter of constant component

A filter of constant component can be proposed as an effective tool enabling determination of a constant component signal. The constant component filter can be roughly treated as a lowpass filter with the passband narrowed to a single frequency $\omega = 0$. The stopband of the filter of constant component is determined by the cutoff frequency Ω and the assumed, admissible, value α limiting the amplitudes of the frequency response $|K(j\omega)|$ for $\omega = \Omega$. Therefore, the magnitude response of a constant component filter can be written as [18]

$$|K(j\omega)| \begin{cases} = 1 & \text{for } \omega = 0 \\ < 1 & \text{for } 0 < \omega < \Omega. \\ \leq \alpha & \text{for } \Omega \leq \omega \end{cases} \quad (7)$$

The general filtering requirements given by (7) enable the synthesis of constant component filters. Of course, using relation (7), one cannot explicitly determine the filter structure and its parameters. Thus, the additional filter quality criteria must be taken into consideration.

The filter settling time t_{s1} , i.e. time, that for each $t = t_{s1}$ the filter step response is never more than α different from its final value, can be considered as one among possible quality coefficients for constant component filters design. The evaluation based on a value of the settling time cannot be treated as sufficient for the filters belonging to a class of systems with time-variable parameters. The mentioned quality coefficient does not take into account the altering parameters of the spectral characteristic. Using the formula:

$$S_y(\omega) = S_x(\omega) \cdot |K(j\omega)|^2, \quad (8)$$

which determines the power spectral density of the filter output signal, the new, spectral "measure" of the quality for constant component filters fulfilling relation (7) has been proposed in the form of the following coefficient:

$$g_\eta = \sqrt{\int_0^\infty |K_{t \rightarrow \infty}(j\eta)|^2 d\eta}, \quad (9)$$

where: $K_{t \rightarrow \infty}(j\eta)$ is the transfer function of the time-invariant filter which corresponds to the time-varying filter for $t \rightarrow \infty$, and $\eta = \omega/\Omega$ is the normalized frequency. In [8], it has been proved that a time-varying filter may be regarded as a traditional time-invariant filter when its parameters settle to steady values with time.

The so-called "time of operation" can be calculated either considering the settling time t_{s1} of the step response $h(t)$ fulfilling the following relation:

$$\begin{cases} |1 - h(t_{s1})| = \alpha \\ |1 - h(t)|_{t > t_{s1}} \leq \alpha \end{cases} \quad (10)$$

or considering the time t_{s2} determined by the filter response $y(t)$ to the sine input signal $x_1(t)$, as it follows:

$$\begin{cases} |y(t_{s2})| = 2\alpha \\ |y(t)|_{t > t_{s2}} \leq 2\alpha \end{cases}, \quad (11)$$

where: $x(t) = 1(t) \cdot \sin(\Omega t + \varphi)$.

It has been assumed that the amplitudes of the input step functions as well as the input sine signals are identical and equal to the amplitude range of the filter input. The longer from the times t_{s1} , t_{s2} has been established as the operation time t_s , deciding about the filter quality. The

results of calculations and simulations can be easily compared when the relative operation time will be introduced in the following form:

$$t_r = \frac{t_s}{T_\Omega}, \quad (12)$$

where: T_Ω denotes the period corresponding to the angular frequency Ω . All the calculations and comparisons have been carried out for $\alpha = 0.05$.

The filter quality coefficient k has been assumed in the form:

$$k = t_r \cdot g_\eta. \quad (13)$$

The product (13) is sensitive for filter improvements created by the introduction of time-varying parameters. The idea of the choice of the quality coefficient in the form (13) can be supported by the following reasoning: the first factor, i.e. the operation time, expresses the duration of the transient state under spectral assumptions (7), the second one determines additional damping of the harmonic components of the signal (comparing to the damping resulting from assumptions (7)). It can be easily perceived that minimizing the coefficient k one improves the quality of the filter [18, 19]. Of course, the coefficient k can be successfully applied to comparative evaluations of constant component filters of both types, i.e. filters with constant and time-varying parameters.

4. Time-Varying Filter

Dynamic properties of a lowpass or constant component filter are entirely described by the natural frequency ω_0 and the damping ratio β .

In this paper, we consider a second-order filter of constant component whose parameters change with time. This kind of filter can be described by the following differential equation:

$$\omega_0^{-2}(t) \cdot y''(t) + 2\beta(t)\omega_0^{-1}(t) \cdot y'(t) + y(t) = x(t), \quad (14)$$

where: $x(t)$ and $y(t)$ are respectively the filter input and output, $\omega_0(t)$ is a function of the characteristic frequency of the filter and $\beta(t)$ is a function of the damping ratio.

It is well known that the higher the value of the natural frequency ω_0 , the shorter the transient of the filter. On the other hand, the smaller the value of the damping ratio β , the smaller the rise time of the filter, and the larger the overshoot. On the basis of computer simulations, previous investigations [18], and the above mentioned rules, the functions of filter parameters were formulated as follows:

$$\omega_0(t) = [1 - c_1 \cdot h_1(t)] \cdot \bar{\omega}_0, \quad (15)$$

$$\beta(t) = [b_1 + b_2 \cdot h_2(t)] \cdot \bar{\beta}, \quad (16)$$

where: $\bar{\omega}_0$ and $\bar{\beta}$ are respectively the natural frequency and the damping ratio following from the filter approximation, and c_1 , b_1 , and b_2 are the function coefficients which describe the variation ranges of functions given by (15) and (16). Functions $h_1(t)$ and $h_2(t)$ are the step responses of the second-order supportive systems $H_{s1}(s)$ and $H_{s2}(s)$, i.e. $h_1(t) = \ell^{-1}[s^{-1} \cdot H_{s1}(s)]$ and $h_2(t) = \ell^{-1}[s^{-1} \cdot H_{s2}(s)]$. These functions have the following forms:

$$h_1(t) = \ell^{-1} \left[\frac{1}{s} \cdot \frac{1}{(\omega_{01})^{-2} s^2 + 2\beta_1(\omega_{01})^{-1} s + 1} \right] = [1 - (1 + \omega_{01}t) \exp(-\omega_{01}t)] \cdot 1(t) \quad \text{for } \beta_1 = 1 \quad (17)$$

and

$$h_2(t) = \ell^{-1} \left[\frac{1}{s} \cdot \frac{1}{(\omega_{02})^{-2} s^2 + 2\beta_2 (\omega_{02})^{-1} s + 1} \right] =$$

$$1(t) - \left[\cos(\omega_{02} t \sqrt{1 - \beta_2^2}) + \frac{\sin(\omega_{02} t \sqrt{1 - \beta_2^2})}{\sqrt{1 - \beta_2^2}} \right] \cdot \exp(-\beta_2 \omega_{02} t) \cdot 1(t) \quad \text{for } \beta_2 < 1. \quad (18)$$

The parameters ω_{01} and ω_{02} determine the variation rates of the functions $\omega_0(t)$ and $\beta(t)$, respectively. For experiment needs, the variation ranges of the functions $\omega_0(t)$ and $\beta(t)$ have been chosen in the following way:

$$\frac{\omega_0(0)}{\bar{\omega}_0} = 10 \quad \text{and} \quad \frac{\beta(0)}{\bar{\beta}} = 0.5, \quad (19)$$

which means that in the initial phase of the filter work the natural frequency is 10-times greater and the damping ratio 2-times smaller than the values following from the approximation, i.e. when the parameters are settled.

Fig. 2 presents a detailed model of the time-varying filter of constant component which has been considered in this paper. In the experiment the following data have been used: $\bar{\omega}_0 = 0.0235$, $\bar{\beta} = 1.2$, $\omega_{01} = 0.1333$, $\omega_{02} = 0.16$, $\beta_1 = 1$, $\beta_2 = 0.9$, $c_1 = 0.9$, $b_1 = 0.5$, and $b_2 = 0.5$. A classical implementation of the time-varying filter described in this paper requires the use of multipliers, adders, and four additional integrators which form the supportive systems. As one can notice, the overall complexity of the system underwent a significant increase due to the presence of the systems generating $\omega_0(t)$ and $\beta(t)$. However, in situations in which the transient duration should be as short as possible this complexity increase may be profitable.

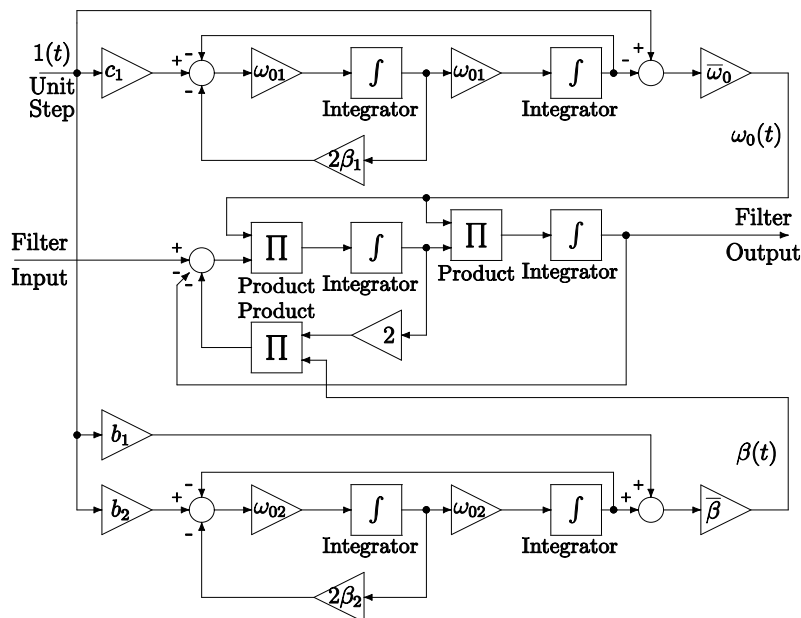

Fig. 2. Block diagram of the time-varying filter of constant component.

5. Multiplexing System

The time-varying filters can be useful in many signal processing applications. However, these filters are useful if we know the moments in which the filter parameters should be

changed. Such a situation appears in multiplexing systems. A block diagram of the signals multiplexing system with the time-varying filter of constant component is shown in Fig. 3.

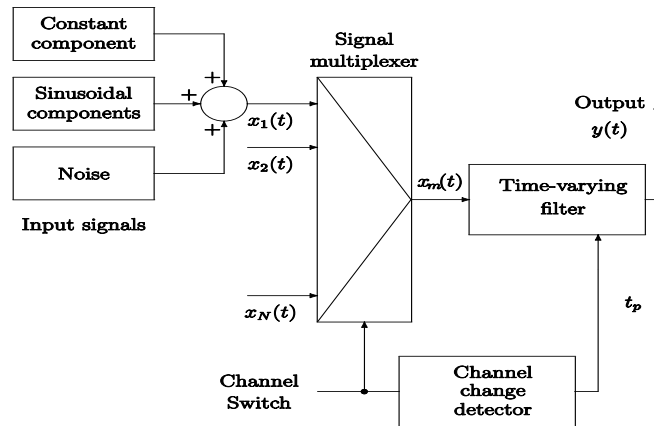

Fig. 3. Block diagram of the signals multiplexing system with the time-varying filter.

Each of N signals from multiplexer inputs $x_N(t)$ consists of a useful constant component, undesired harmonic components, and noise. The input signals are switched according to the control signal which is fed to the channel switch input. As a result of the switching process, a rectangular signal with additive noise, denoted by $x_m(t)$, is transferred to the multiplexer output. Such a signal is presented in Fig. 4.

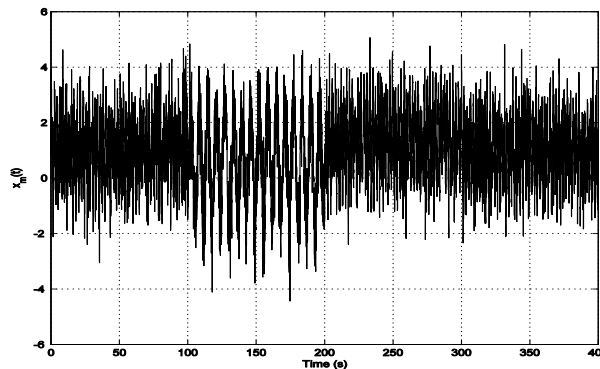

Fig. 4. Rectangular signal with additive noise from the multiplexer output.

The functions $\beta(t)$ and $\omega_0(t)$ which vary the parameters of the filter are presented in Figs. 5 and 6, respectively. The multiplexer is switched every 100 s, so the functions $\beta(t)$ and $\omega_0(t)$ are generated periodically. However, in general, it is possible to switch the multiplexer with arbitrary frequency, and unnecessarily periodically.

Fig. 7 shows the results of the filtering process in the signals multiplexing system by using the time-invariant filter and its time-varying equivalent.

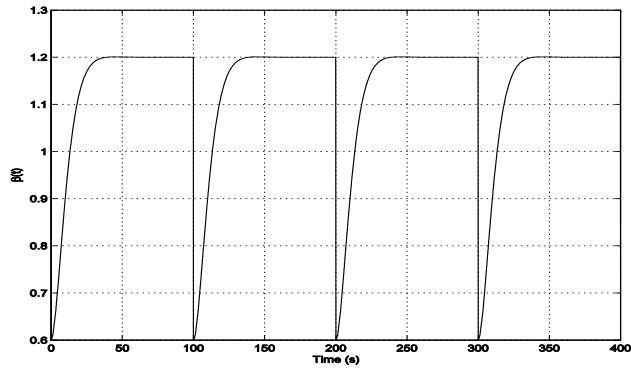

Fig. 5. Function $\beta(t)$.

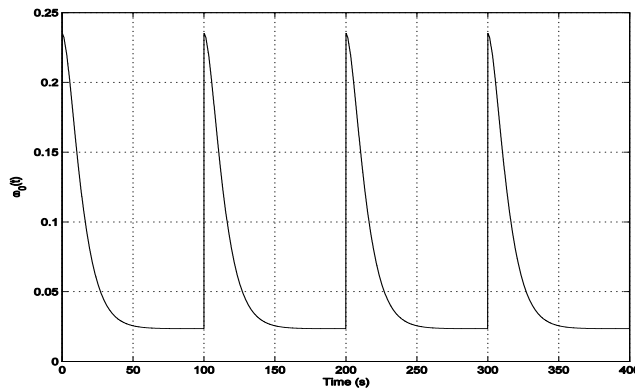

Fig. 6. Function $\omega_0(t)$.

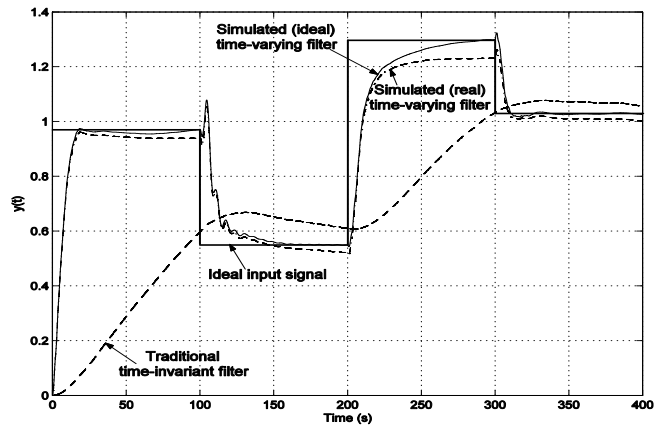

Fig. 7. Results of filtering using traditional time-invariant filter and time-varying filter of constant component.

How one can notice, the introduction of the time-varying filter to the signals multiplexing system yields good results. While the traditional time-invariant filter is not able to work out the useful constant component signal, the time-varying filter is considerably faster, and is able to follow the shape of the ideal rectangular signal.

Fig. 7 also presents the comparison between the ideal and "real" time-varying filter which was considered in the paper. The characteristic labeled by the simulated (ideal) filter presents the response of the filter in which all product systems (see Fig. 2) are ideal, and the characteristic labeled by the simulated ("real") filter presents the response of the filter in which all product systems are simulated as "real" with dead-zone nonlinearities. As one can see, the influence of the nonlinearities is noticeable, however, not significant.

In the future, the proposed filter configuration will be implemented with the aid of the dynamic translinear technique [20]. This technique should minimize the influence of nonlinearities which are typical for classical multiplier circuits. By using the dynamic translinear principle, it is possible to implement linear and nonlinear differential equations, using transistors and capacitors only. Dynamic translinear circuits are excellently tunable across a wide range of several parameters, such as cutoff frequency, quality factor and gain, which increases their designability and makes them attractive to be used as standard cells or programmable building blocks. In fact, the dynamic translinear principle facilitates a direct mapping of any function, described by differential equations, onto silicon.

At the end of this paper, it is worth to add that the proposed filter structures can be easily transformed to digital filters. For that purpose, the continuous-time integrators (from Fig. 2) should be transformed to their digital equivalents with the aid of the well known bilinear transform.

6. Conclusions

As it has been proven, the introduction of time-varying coefficients to the filter of constant component yields good results. By using the described filtering approach it is possible to obtain an efficient filter that ensures a very fast response if compared with the traditional time-invariant filter. Such a designed filter was used to the signals multiplexing system, where it confirmed its good properties. It seems that further examinations of time-varying filters of constant component are needed.

Acknowledgements

The authors would like to thank the anonymous reviewer who contributed to improve the quality and clarity of this paper with her/his comments during the revision process.

This work has been supported by the Foundation for Polish Science (FNP) and the Ministry of Science and Higher Education of the Republic of Poland under grant contract N N505 484740.

References

- [1] Żuchowski, A., Grzywacz, B. (2007). Concept of match for filtration of disturbance with simultaneous faithful restoring of big jumping change of signal. *PAK*, (12), 3-4. (in Polish)
- [2] Yang, H., C., Allstot, D., J. (1990). Considerations for fast settling operational amplifiers. *IEEE Trans. Circuits Syst. I*, 37(3), 326-334.
- [3] Marques, A., Geerts, Y., Steayert, M., Sansen, W. (1998). Settling time analysis of third order systems. In *Proc. IEEE ICECS*, 2, 505-508.
- [4] Schlarmann, M., E., Geiger, R., L. (2001). Technique to eliminate slow-settling components that appear due to dipoles [multipath compensated amplifiers]. In *Proc. IEEE MWSCAS*, 1, 74-77.
- [5] Pugliese, A., Cappuccino, G., Cocorullo, G. (2008). Design procedure for settling time minimization in three-stage nested-Miller amplifiers. *IEEE Trans. Circuits Syst. II*, 55(1), 1-5.
- [6] Piskorowski, J., Barciński, T. (2008). Dynamic compensation of load cell response: a time-varying approach. *Mech. Systems and Signal Processing*, 22(7), 1694-1704.
- [7] Pietrzak, P. (2008). Fast filtration method for static automatic catchweighing instruments using a nonstationary filter. *Metrology and Measurement Systems*, 16(4), 669-676.
- [8] Jaskuła, M., Kaszyński, R. (2004). Using the parametric time-varying analog filter to average-evoked potential signals. *IEEE Trans. Instrumentation and Measurement*, 53(3), 709-715.

- [9] Jaskuła, M., Kaszyński, R. (2002). Averaging BAEP signals with parametric time-varying filter. *Metrology and Measurement Systems*, 4(2), 171-178.
- [10] Kaszyński, R., Piskorowski, J. (2007). Selected structures of filters with time-varying parameters. *IEEE Trans. Instrum. Meas.*, 56(6), 2338-2345.
- [11] Piskorowski, J. (2008). Some aspects of dynamic reduction of transients duration in delay-equalized Chebyshev filters. *IEEE Trans. Instrum. Meas.*, 57(8), 1718-1724.
- [12] Piskorowski, J., Kaszyński, R. (2007). A novel concept of phase-compensated continuous-time filters. *Analog Integrated Circuits and Signal Processing.*, 51(1), 39-44.
- [13] Piskorowski, J., Gutierrez de Anda, M., A. (2009). A new class of continuous-time delay-compensated parameter-varying lowpass elliptic filters with improved dynamic behavior. *IEEE Trans. Circuits Syst. I, Reg. Papers.*, 56(1), 179-189.
- [14] Piskorowski, J. (2009). A concept of Q -varying continuous-time notch filter with improved dynamic behavior. In *Proc. IEEE I²MTC.*, 913-917.
- [15] Piskorowski, J. (2010). Digital Q -varying notch IIR filter with transient suppression. *IEEE Trans. Instrum. Meas.*, 59(4), 866-872.
- [16] Kaszyński, R., Piskorowski, J. (2007). Time-varying filtering in switching systems. In *Proc. IEEE IECON.*, 2548-2552.
- [17] Piskorowski, J., Kaszyński, R. (2007). A non-standard method of signals filtering in systems containing analog multiplexers. In *Proc. IEEE ISIE.*, 1751-1754.
- [18] Kaszyński, R. (2001). The parametric filter of signal constant component. In *Proc. IEEE ISCAS.*, 200-203.
- [19] Kaszyński, R. (1998). The properties of parametric filter of signal constant component. *Metrology and Measurement Systems*, 5(4), 303-313.
- [20] Mulder, J., Serdijn, W., A., van der Woerd, A., C., van Roermund, A., H., M. (1999). *Dynamic Translinear and Log-Domain Circuits – Analysis and Synthesis*. The Springer International Series in Engineering and Computer Science, 481.