

J. BAST*

A NEW METHOD FOR THE MEASUREMENT OF FLOWABILITY OF GREEN MOULDING SAND**NOWA METODA POMIARU PŁYNNOŚCI KLASYCZNEJ MASY FORMIERSKIEJ**

The production of castings by green sand moulds is a very important method for the manufacture of final products for different sectors of industry. In this green sand moulding process the quality of castings depends strongly on the quality of the mould, which in turn is determined by parameters such as the type of foundry machine, the characteristics of the moulding sand and the specifications of the patterns. The mould's stability for use casting is achieved by filling and compacting moulding sand. This means, that the clay-bonded moulding sand is changed from the free flowing to the compacted state. In this process flowability is a very important parameter. Therefore, a variety of methods for the determination of flowability have been in use. However, it is fair to say that these methods do no longer meet the requirements of the modern moulding process. This paper introduces a new method for the determination of flowability of clay-bonded moulding sand using a specifically designed type of density sensor that was developed by a research team led by Professor Jürgen L. Bast at the Mechanical Department of Technical University Bergakademie Freiberg. The high levels of accuracy in the determination of flowability that this method is capable of achieving have been tested and indeed proven by varying sand parameters such as water and clay content, grain composition, mixing time, and compaction pressure. A further innovative characteristics of this new method of sensor-based flowability measurement is the possibility of using the sensor not only for the lab-based testing of sands but in the actual mould during the production process in the foundry, which allows to determine whether the sand in the mould has the required qualities based on real-time flowability measurements.

Keywords: Clay-bonded moulding sand, compactability, flowability, measurement methods

Produkcja odlewów w formach wilgotnych jest bardzo ważną metodą w wytwarzaniu finalnych wyrobów w wielu dziedzinach przemysłu. W procesie formowania "na wilgotno" jakość odlewów zależy istotnie od jakości formy, która z kolei jest określona przez takie parametry jak: rodzaj maszyny formierskiej, charakterystyka masy formierskiej oraz parametry modeli. Stabilność formy odlewniczej jest osiągnięta podczas wypełniania przestrzeni technologicznej oraz zagęszczania masy formierskiej. Oznacza to zmianę stanu masy formierskiej od stanu luźno usypanego do stanu zagęszczonego. W tych procesach płynność masy jest bardzo ważnym parametrem. Dlatego też, stosowanych jest wiele metod określania płynności masy. Trudno jest jednak stwierdzić, że metody te spełniają wymagania nowoczesnych procesów formowania.

W artykule zaprezentowano nową metodę określania płynności mas z lepiszczem, wykorzystującą specjalnie zaprojektowany czujnik zagęszczenia – opracowany w zespole badawczym kierowanym przez Profesora Jürgena Basta na Wydziale Mechanicznym Uniwersytetu Technicznego (Akademii Górniczej) we Freibergu.

Wysoki poziom dokładności określania płynności, który może być osiągany w tej metodzie, został wykazany badaniami testowymi, przy zmiennych parametrach: wilgotności masy i zawartości lepiszcza, składu ziarnowego osnowy, czasu mieszania masy oraz wartościach nacisków podczas zagęszczania.

Kolejne cechy innowacyjne tej nowej metody określania płynności z zastosowaniem wspomnianych czujników to możliwość jej wykorzystania nie tylko w warunkach badań laboratoryjnych masy, ale również podczas procesu wytwarzania form w odlewni. Umożliwia to określenie w czasie rzeczywistym, czy masa wykorzystywana w procesie formowania ma wymaganą jakość.

1. Introduction

The production of castings using clay-bonded sand moulds continues to be a very important method for the manufacturing of parts for use in various different branches of industry. In this case the quality of castings depends very strongly on the quality of the mould. The quality of the mould, in turn, is determined by parameters such as the specification

of the moulding machine (e.g. method and pressure of sand compaction, pressure time, lifting speed of flask), the characteristics of the moulding sand (e.g. content of bentonite and water, dimension and geometry of sand grains, compactability and flowability of moulding sand, kind of mixer), and the features of the pattern (e.g. geometry, surface, dimensions, i.e. length, width and height, holes in the pattern, drafts as well as the distance between the pattern and the flask wall

* TU BERGAKADEMIE FREIBERG, FREIBERG, GERMANY

or between different patterns arranged on one single pattern plate) (1,2,3,4,5).

The production of moulds is carried out by moulding machines. The actual moulding process includes the transfer of moulding sand from the free flowing state into the solid state by its compaction [2, 4, 5]. For this the prepared moulding sand is filled into the moulding volume, which consists of the flask with its frame and of the pattern plate, which carries several patterns. Once the moulding sand has been filled into the moulding volume it is being compacted using a variety of different processes. The authors E. Flemming and W. Tilch [4] define these processes as the 'process of the creation of the pre-contour' and the 'process of the compaction of the final contour'. Afterwards the flask is lifted from the pattern plate ('process of preservation of the contour'). During these processes the moulding sand creates the mould and it obtains the usability properties that make it fit for the pouring and solidification of melt.

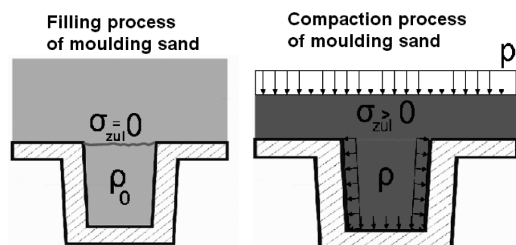

Fig. 1. Contour creation processes of mould; σ_{zul} – stress in the critical zone

The pattern geometries are often very difficult and varied during the production process. Furthermore, the composition of the moulding sand must be such that it fits the requirements of both, the moulding and the pouring/solidification. As a result of thermal interaction with the liquid metal the properties of the moulding sand are subjected to change and do not remain constant.

For the filling and compaction process a great number of different methods are being used, which are based on a variety of principles, such as squeezing, jolting, air flow pressing, air impact and others. In any case, it is helpful to differentiate between flowability during the filling process (usually only under the influence of gravity) and flowability during the compaction process in the moulding phase under the influence of pressure forces.

The qualitative lifting of moulding sand parts from pattern plate depends very strongly on flowability of moulding sand.

2. Properties and behaviour of clay-bonded moulding sands and moulds

The grains of the moulding sands are discrete particles and bigger than $1 \mu\text{m}$, so that they can call disperse solid materials [6, 7, 8] or granular cohesive mediums [8, 9, 10]. Under certain conditions they can have properties of liquid or solid materials. Under the assumption that the particles of the moulding sand are very small in comparison to the investigated mould parts they are considered as homogeneous continuums.

During the using of the sand mould cohesion and adhesion forces are acted in the prepared free flowing clay-bonded moulding sand. The stress-strain curve of moulding sand is nonlinear. The main factors, which determine the account of these forces, are composition, grade of preparation and the density [2, 4, 11, 12, 15].

3. Interactions of the filling and compacting processes

At the investigation of flowability the main focus is liquids, which have very good flowability. The flowability of materials can be described by rheologic laws [6, 11, 13, 14].

The flowability of liquids and gases is characterized by viscosity, which reflects the internal friction and the deformation resistance of fluid. In comparison to Newtonian fluids the Non-Newtonian fluids their viscosity is not constant. These fluids have a viscosity, which is changed by varied shear stresses.

The simplified model of rheologic complex fluids is the Bingham liquid model. The model and shear stress-shear rate-diagram are showed in Fig. 2, 3. In the fluid there is no movement before reaching of the critical shear stress τ_0 .

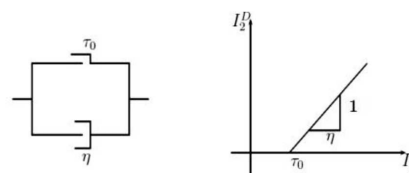

Fig. 2. Bingham model of liquid [9]

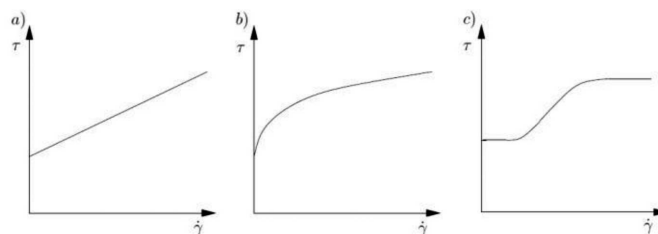

Fig. 3. Flow curves a) Bingham-model, b) Herschel-Bulkley-model, c) Cross-model

The flowability of cohesive clay-bonded moulding sands can be described on the base of models and laws of continuum mechanics by dynamic stress limit functions (Mohr-Coulomb-circle) [15, 16]. The Coulomb flowing criterion is true only for the special case of constant density [6, 16]. In the compaction of moulding sand the change of density is great and cannot be ignored. In addition to the internal friction and the cohesion the density of moulding sand is an influence parameter. For the determination of flow limit of real moulding sands with special regard of varied moulding sand density yield locus can be used [17, 21]:

- at small compression strength the yield locus has a non-linear trend.
- the yield locus has an end point at increased compression strength.
- the position of yield locus depends on the bulk density.

The end points of the yield locus's and also the stress circles, which tangent the yield locus's in the end points, characterize the stationary flowing at constant density.

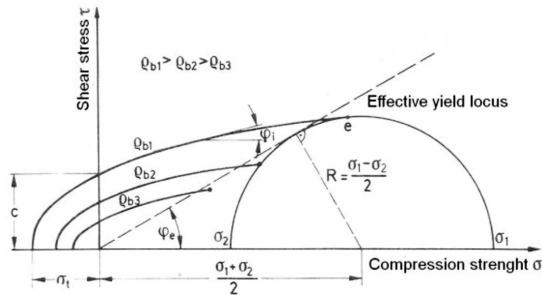

Fig. 4. Yield locuses and effective yield locus [16]

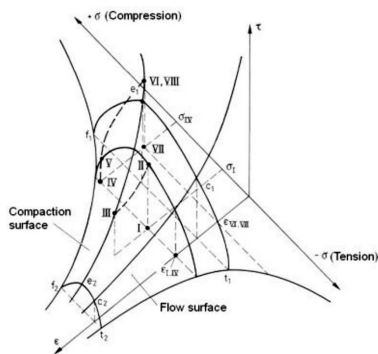

Fig. 5. Three-dimensional diagram by K. Roscoe [16]

With the help of an three-dimensional diagram, which was set up first time in the soil mechanics by K. Roscoe [6, 16], with three parameters: normal strength σ , shear stress τ and density of moulding sand ρ_b it is possible to describe the flowing and compacting behaviour of moulding sand and in a moulding cog the tension, compression and shear stress can be calculate. The porosity ε lies on the third axis (Fig.5), which have a relationship between the bulk density ρ_b and the compacted density ρ_s :

$$\varepsilon = 1 - \rho_b / \rho_s \quad (1)$$

4. Method for the measuring of flowing and compacting properties of moulding sand

4.1. Compactability method of Hofmann and flowability method of Orlov

Today in the foundry industry for the determination of flowing properties of moulding sand the compactability method of Hofmann [19] is used widely [4]. Essential disadvantage of this method lies in the fact, that the possible decreasing of the moulding sand high in the tube of specimen is relevant only for the press compaction and only for simple patterns. Tilch, W. et. al. [4, 14] have shown, that in closely moulding cogs at equivalent compacting parameters a decreasing of moulding sand density is observed with increasing of the compactability of moulding sand. The flowability method of G. Orlov [20] has the same disadvantages.

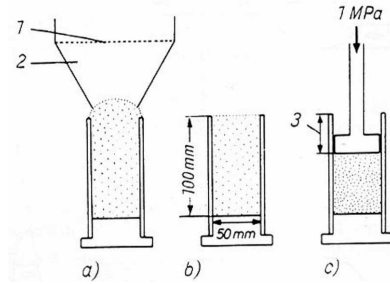

Fig. 6. Compactability method of F. Hofmann [19]

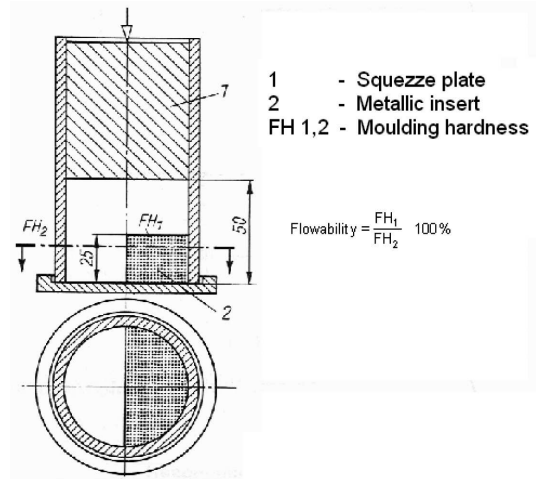

Fig. 7. Flowability method of G. Orlov [20]

4.2. Flowability method of Levelink

Using the flowability method of Levelink moulding sand (400 g) is filled in a bunker by a screen (Fig. 8). The bunker has a very fast opening flap. The moulding sand falls on a sheet with four holes (diameter: 35 mm). The relationship between the mass of sand, which is falling through the holes, and the total mass is called the flowability in percent (%) [18].

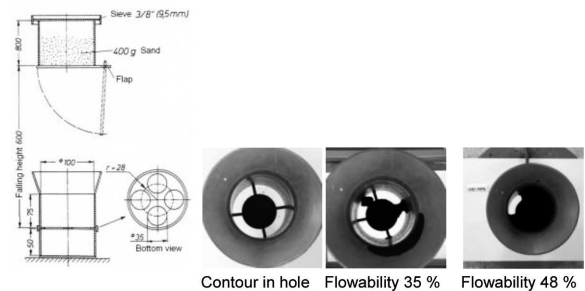

Fig. 8. Flowability method of Levelink [18]

The value of flowability of no-compacted moulding sand is used for the quality testing of moulding sand properties for mould production process by moulding machines. It is possible to decide which water content is optimal for the filling of pattern cogs [18, 21].

4.3. Flowability method of Georg Fischer

For the determination of flowability of Georg Fischer [22] the moulding sand (mass is equivalent the

50-mm-standard-specimen) is filled by screen in a special tube and compacted by 3 strokes (Fig. 9). In this process the moulding sand is pressed into the spread of tube (Fig. 10).

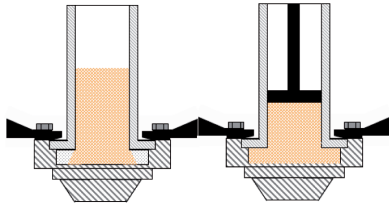

Fig. 9. Flowability method of Georg Fischer



Fig. 10. Values of Georg Fischer flowability at different values of compactability of sand

4.4. Deformation diagram of Boenisch [23]

For the creation of deformation diagram a cylindrical standard specimen is loaded by pressure (Fig. 11). The device recorded a stress-strain-diagram (Fig. 12). The angle of the decreased curve after the peak of compression strength is the compactability value of moulding sand. This value can range from 0° (embrittled) to 90° (very good deformable).

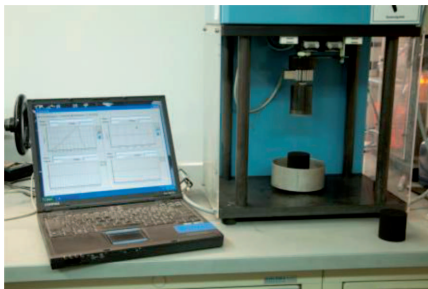

Fig. 11. Deformation equipment of Boenisch

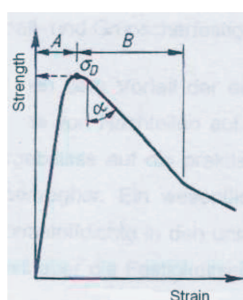

Fig. 12. Angle α as deformation value

Today despite of many investigations of flowability of moulding sand there are not a suitable method for the measurement of flowability, which can be used for the optimisation

of moulding sand in sand preparation process of the foundries. Furthermore, the development of new test method stagnates, but the production process of green sands moulds is changed.

5. Developing of compactability sensor

At the Department of Foundry Machines (TU Bergakademie Freiberg) a compactability sensor was developed. Fig. 13 shows the schematic construction of sensor.

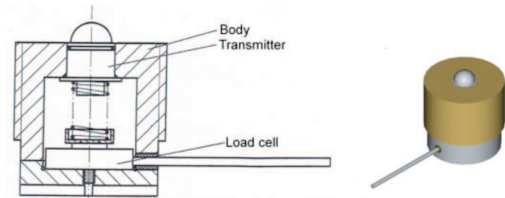

Fig. 13. Compactability sensor

The sensor gives a signal only in the case, when the stress state of moulding sand is changed. It is installed into pattern plate and only a pin is higher the plate. At the change of the stress state of moulding sand the pin is pressed into the body. The force is translated to a load cell by a spring (Patent DE 10046491 C1 [24]). On the base of relevant calibration procedures this sensor can be measured the density and the green properties of moulding sand.

6. A new method of flowability determination

Using this sensor a new method for the determination of flowability has been developed. The dimensions of the tube are 80 mm in diameter and 140 mm in height. An insert containing both sensors is located into the tube. The difference between the sensors place at the lower and at the upper level is 30 mm. The moulding sand is sieved into the tube. After this any excess moulding sand is scrapped, the tube is placed into the press and the moulding sand is compacted by plunger. The time and the value of pressure can be varied using a control programme. The decrease of height and the force of pressure are measured by way and pressure measuring devices respectively.

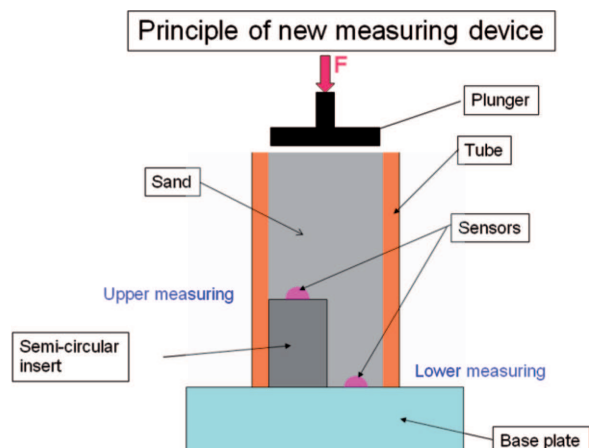

Fig. 14. Principle of the new flowability device

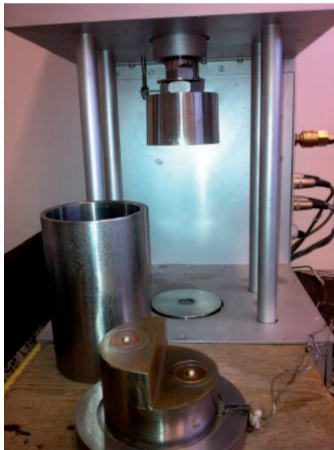

Fig. 15. Flowability device

During the compaction process the control programme registers the flowability curves.

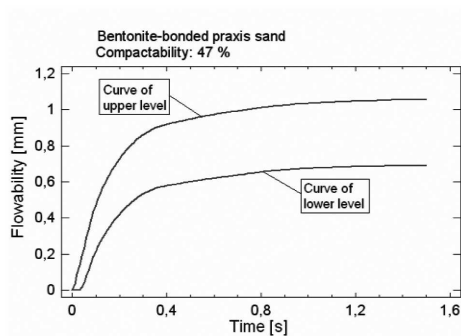

Fig. 16. Flowability curves at the lower and upper levels

7. Possible values of flowability

Given that this method has just been developed, only a limited number of basic measurements can be presented at this point since further more detailed tests are still being carried out. The interpretation of the curves registered during the experimental tests so far allows for the formulation of a number of flowability values. The most straightforward case is the registration of value at the lower level. Furthermore, it

is possible to assess the relationship between values measured at the lower and the upper levels and to define the result as flowability. A useful measure of flowability can be defined by taking into account two premises:

1. Value at the lower level must be high,
2. Relationship between lower and upper level must be 1.

In this case flowability can be expressed as a function of the following formula:

$$FB = MP + \frac{MP}{PP} \quad (2)$$

whereby:

FB – Flowability

MP – Value of the lower sensor

PP – Value of the upper sensor

A value of flowability can also be calculated based on the gradient of the curves. The curves can be expressed by the following a function:

$$FB = \tanh(ax)x_{end} \quad (3)$$

whereby:

FB – Flowability

x – Measured value

x_{end} – End value of the curve

a – Slope

The slope can be calculated by regression.

At present all these conclusions have not yet been tested in detail and must be confirmed in future investigations.

8. Basic tests

8.1. Reproducibility of measurement

In order to test the practical usefulness of a new method it is necessary to make experiments under the same conditions (reproducibility of values). In this case the shape of curves as recorded at the lower and at upper levels has been defined as the value of flowability. The experiments were carried out using clay-bonded and bentonite-bonded moulding sand. Dispersions characteristics were calculated.

TABLE 1

Dispersion of the measuring values of new method

No. of ex-periment	Bentonite-bonded sand 16% compactability		Bentonite-bonded sand 47% compactability		Clay-bonded sand 52% compactability	
	MP lower level	PP upper level	MP lower level	PP upper level	MP lower level	PP upper level
1	0.302	0.365	0.762	1.115	0.965	2.089
2	0.347	0.375	0.662	1.059	1.029	2.062
3	0.274	0.377	0.663	1.061	0.986	2.101
4	0.315	0.342	0.706	1.945	0.986	2.101
5	0.3035	0.364	0.6332	1.19	0.949	2.049
Dispersion	±0.0302	±0.0160	±0.0423	±0.0351	±0.0300	±0.023

As the figures below show, the dispersion at the lower level is higher, while it is lower at the upper level. In the upper part of the tube the levels of internal and external friction are lower.

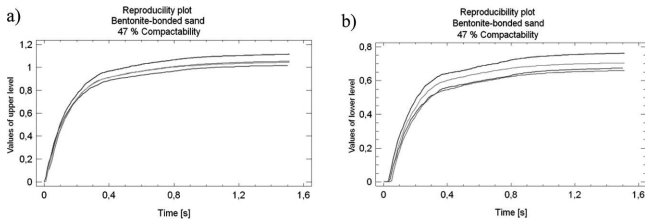

Fig. 17. Reproducibility plot of measured signal at lower (a) level at upper level (b) at bentonite-bonded sand (compactability: 47%)

8.2. Experiments based on the new flowability method

The following moulding sands were investigated:

1. Bentonite-bonded synthetic new sand (5% bentonite)
2. Bentonite-bonded synthetic praxis sand (7% bentonite)
3. Clay-bonded natural sand for Fe-alloys (13% fine particles)
4. Clay-bonded natural sand for Cu-alloys (15% fine particles)

During the investigation the water content and the compactability were varied. In the figures the function $FB=MP+MP/PP$ is chosen to express flowability values.

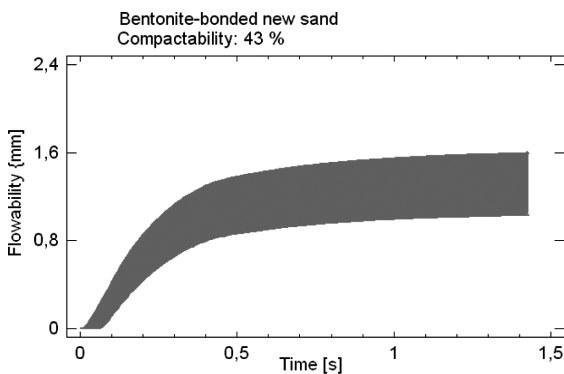

Fig. 18. Flowability curves of bentonite-bonded new sand at 43% compactability

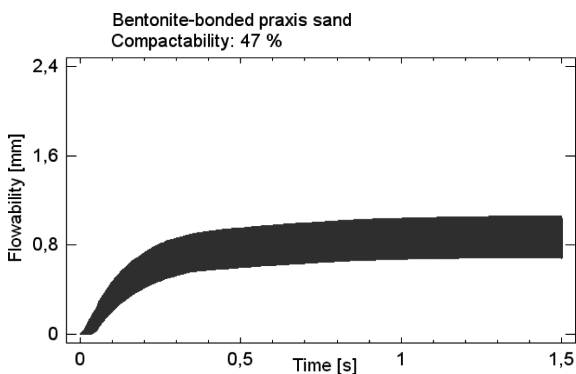

Fig. 19. Flowability curves of bentonite-bonded praxis sand at 47% compactability

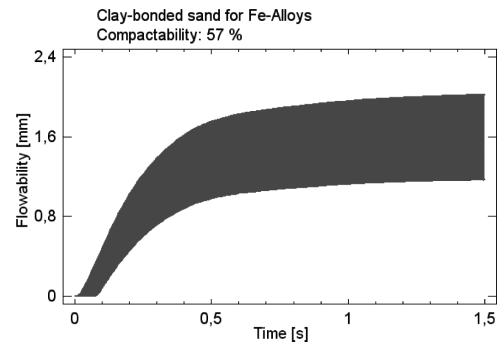

Fig. 20. Flowability curves of clay-bonded sand for Fe-alloys at 57%

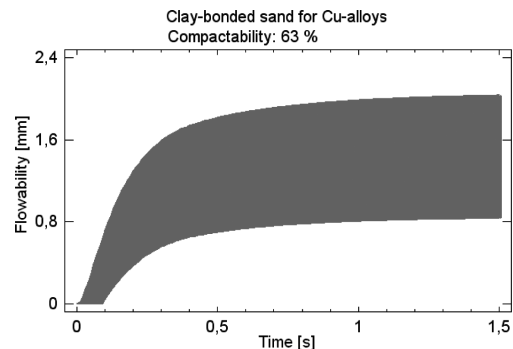

Fig. 21. Flowability curves of clay-bonded sand for Cu-alloys at 63%

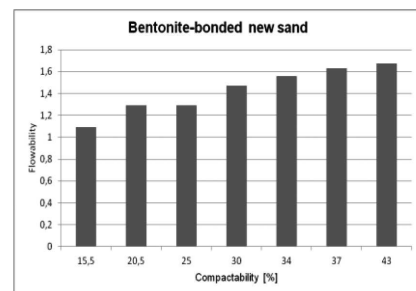

Fig. 22. Compactability-flowability-diagramm of bentonite-bonded new sand

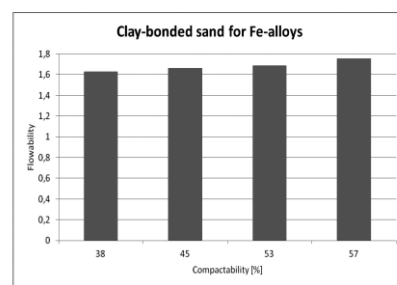

Fig. 23. Compactability-flowability-diagramm of clay-bonded praxis sand for Fe-alloys

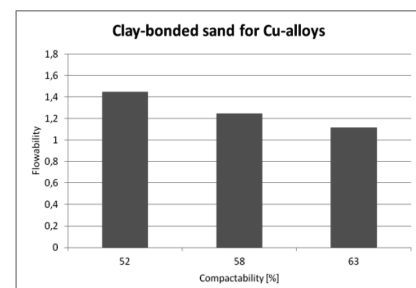

Fig. 24. Compactability-flowability-diagramm of clay-bonded praxis sand for Cu-alloys

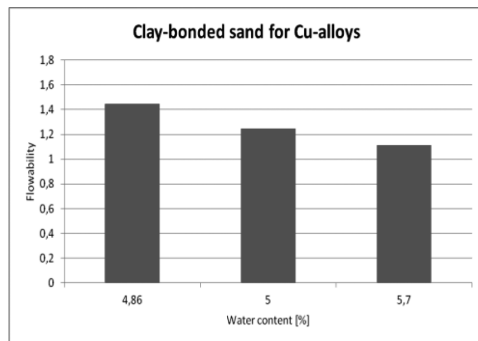

Fig. 25. Water-content-flowability-diagramm of clay-bonded praxis sand for Cu-alloys

9. Flowability-nomograph

It is possible to create a flowability-nomograph by using of the function $FB = MP + MP/PP$. In comparison to the compactability curve the curves of flowability in this nomograph follow a linear trend. Thus this nomograph is a very useful way to assess the impact of water content in moulding sand preparation systems.

Furthermore, the insert with the sensors can be installed onto the pattern plate for the determination of the flowing behaviour of moulding sand directly during the compaction process of the moulding sand in the flask. Under these conditions a criterion for the flowing behaviour can be developed that is suitable for both, moulding sand testing in the laboratory and during the production process.

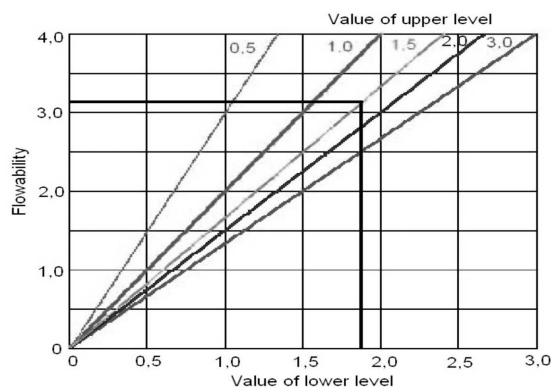

Fig. 26. Flowability-nomograph

10. Conclusion

A new method for determining flowability of moulding sand during compaction has been developed. This new method has been tested in a series of preliminary experiments carried out with the help of a specifically designed measure device. The interpretation of the curves that are being registered by two sensors, which are positioned at the lower and the upper level of the testing device, allows for the formulation of a variety of criteria of flowability. Taking into account that the best flowability is reached when the value that is measured at the lower level is high and the relationship between the of

values at the lower and the upper level reaches a value of one, a flowability function can be derived. This function shows a linear trend and can be used for the control of water content in moulding sand preparation systems. The testing device can be used directly in the flask during the actual mould production process. However, the concrete outcomes of this preliminary series of tests have not been discussed in detail here since further tests are necessary in order to be able to arrive at definitive conclusions.

REFERENCES

- [1] J. Bast, W. Simon, E. Abdullah, Investigation of cogs defects reason in green sand moulds. *Archives of Metallurgy and Materials* **55**, 3, 749-755 (2010).
- [2] Kadauw, J. Bast, D. Fiedler, I. Betchvaia, H.C. Saewert, Computer simulation of squeeze moulding and validation of results using industrial computer tomography (ICT), *Archives of Metallurgy and Materials* **52**, 3, 733-490 (2007).
- [3] E. Ziótkowski, R. Wrona, K. Smyksy, Some aspects of monitoring of foundry moulding sands preparation process. *Archives of Metallurgy and Materials* **54**, 2, 399-411 (2009).
- [4] E. Fleming, W. Tilch, *Formstoffe und Formverfahren*. Deutscher Verlag für Grundstoffindustrie, Leipzig - Stuttgart 1993.
- [5] M. Ślęzyk, K. Smyksy, Analysis of basic phenomena occurring in the vacuum-assisted moulding process. *Archives of Metallurgy and Materials* **52**, 3, 453-469 (2007).
- [6] K. Te Nijenhuis, G.H. McKinley, S. Spiegelberg, H.A. Barnes, N. Aksel, L. Heymann, J.A. Odell, *Non-Newtonian Flows*, in: C. Tropea, A.L. Yarin, J.F. Foss, *Springer Handbook of Experimental Fluid Mechanics*, Springer-Verlag, Berlin, 2007.
- [7] T. van Vliet, J. Lyklema, *Rheology*, in: L. Lyklema, *Particulate Colloids*, Elsevier, Amsterdam, 2005.
- [8] Y. Forterre, O. Pouliquen, *Flows of dense granular media*. *Ann. Review Fluids-Mech.*, 2008.
- [9] D. Schulze, *Pulver und Schüttgüter - Fließeigenschaften und Handhabung*, Springer-Verlag. Berlin - Heidelberg, 2009.
- [10] A.W. Jenike, *Gravity flow of bulk solids*. Bull. No. 108, Engng. Exp.
- [11] G. Böhm, *Strömungsmechanik nicht-newtonscher Fluide*. Stuttgart Teubner-Verlag, Stuttgart, 1981.
- [12] B. Uttera, R.P. Behringer, Transients in sheared granular matter, *The European Physical Journal* **14**, 373-380 (2004).
- [13] A. Rudert, *Experimentelle und Numerische Untersuchung des Kernformstofffließens*, Dissertation, TU Bergakademie Freiberg, 2010.
- [14] R. Schwarze, J. Bast, W. Tilch, A. Rudert, W. Simon, H. Belfaqir, *Modellierung des Kernformstofffließens als nichtnewtonsche Fluidströmung*, TU Bergakademie Freiberg, DFG-Projekt, Abschlussbericht, (2008).
- [15] Malaschkin, *Erarbeitung von Qualitätskriterien zur Einschätzung des Wirkungsgrades von Formmaschinen*, Dissertation, TU Bergakademie Freiberg, 2002.
- [16] M. Roscoe, *Stress-strain behaviour of soil*, Oxfordshire, 1972.
- [17] A. Schröder, *Qualitätssicherung beim Gießen in verlorenen Formen*. *Gießerei* **69**, 21, (1982).
- [18] H.G. Levelink, H. van den Berg, E. Frank, *Kriterien der Sandqualität für moderne Formanlagen*, *Gießerei* **62**, 1, (1975).

- [19] F. H o f m a n n, Tongebundene Formsande. Taschenbücher, Gießerei-Verlag, Düsseldorf, 1975.
- [20] G.M. O r l o v, Influence of flowability on mould squeezeeng process and method of flowability determination, (in Russian). Litiejnoje Proizvodstvo, 8, (1964).
- [21] H.G. L e v e l i n k, Das Trennen des Modells von der Gießform. Gießerei **50**, 18, (1968).
- [22] Fließbarkeitsmessung, Georg Fischer Katalog für Formstoffprüfgeräte des Unternehmens Georg Fischer AG Schweiz.
- [23] D. B o e n i s c h, N. R u h l a n d, Nassgussformen durch sinkende Verformbarkeit gefährdet. Gießerei **74**, 4, (1987).
- [24] J. B a s t, A. M a l a s c h k i n, Verfahren zur Qualitätssicherung und Qualitätskontrolle von Gießformen aus tongebundenen Formstoffen, Patent DE 10046491 C1.

This article was first presented at the VI International Conference "DEVELOPMENT TRENDS IN MECHANIZATION OF FOUNDRY PROCESSES", Inwałd, 5-7.09.2013

Received: 20 January 2013.