

# The Most Suitable 5G Simulator Scenarios for Lab as a Service (LaaS) in Higher Education

Hasanah Putri, and Sinta Novanana

**Abstract**—The 5G System is being developed and enhanced to provide unparalleled connectivity to connect everyone and everything, everywhere. 5G technology use cases depicts the prospects of 5G network model to revolutionize Industry and Education is not an exception. To catch up with the latest technology in the higher education environment there's a need to have 5G Lab as a Service (LaaS) in education to simulate the real network experience. The software is the key to this generation as the virtualization, modularity and abstraction become more popular in the implementation and that the cloud computing is nowadays becoming the trend of technology. This paper presents a software selection between free5gc, magma and open5gs program. The 5G lab located in Jakarta Indonesia has the ability where in physical and virtual resources can be accessed and managed from any location in the world. Free5gc opensource software solution is the most suitable software which can be used as LaaS in Higher Education laboratory. With a LaaS, we can configuration, connection, and troubleshoot 5G infrastructure including radio access networks, core networks, and transportation networks.

**Keywords**—5G; software; LaaS; higher education laboratory; real network experience

## I. INTRODUCTION

THE 5G system is being developed and enhanced to provide unparalleled connectivity to connect everyone and everything, everywhere [1]. Societal changes, witnessed since the explosion of data services, and the growing appetite for wireless broadband have incentivised the speedy development of the fifth generation of cellular systems (5G), envisioned for year 2020 [2]. Rising popularity of 5G communications is making tremendous demands on the cellular network operators for providing true 5G services to the users [3]. 5G is the 5th Generation in telecommunication especially the Cellular communication in which by 3GPP Release 15, has been defined as the phase 1 of implementation for the new technology [4]. In educational institutions the needs to provide practical exercises which are similar like ones that are implemented or use in the industry is very crucial and urgent. The technology itself has grown so fast and the key to catch up with the latest technology is to be ready and prepare our human capital especially those who study at higher education (Polytechnic and University). The number of state university students in Indonesia from 2013 to 2021 is 3.21 million based on [5].

Numerous developing technology paradigms, such as Industry 4.0 [6]–[8], the Internet of Things (IoT) [9]–[10], and

self-driving vehicles [6], [11]–[13], necessitate reliable low-latency communication that is untethered from cables [14]. Proponents of these new technology paradigms have frequently postponed the providing of these essential dependable low latency wireless communication services to the 5th Generation (5G) mobile communication standard proposed by the Third Generation Partnership Project (3GPP) [14]–[16].

As the fifth generation is known for its Software defined technology usage, the demand of having the laboratory for practical exercises seems more visible with the support of opensource solutions namely: (1) free5gc, (2) magma and (3) open5gs. The possibilities to have the 5G lab in education is more likely to happen. This paper is arranged as follows. Section II discusses the software selection between three different opensource available solutions. Section III explains about the step by step of installation of the solutions. Section IV is devoted to discussing possible scenarios using the chosen solution.

## II. METHOD

The selection of opensource software solution is based on the followings listed criteria: (1) 5G SA features, (2) 3GPP Compliance, (3) Private 5G support, (4) Network Slicing, (5) ONAP integration, (6) Easy-to-use, (7) GTP Data plane, (8) Language, (9) Extensible to new NGAP message types and (10) Database. Refers to the Table 1 to see the comparison and the selection criteria [17].

### A. Software Selection

Free5gc opensource software solution was selected due to advance solution and better implementation and that it also provides the radio network solution. The radio network solution in free5gc is the UERANSIM software. It is the opensource state-of-the art 5G UE and RAN (gNodeB) simulator [18]–[20].

The free5gc opensource solution supports all network functions including the radio part. The 5G Core network part consists of Access and Mobility Management Function (AMF), Session Management Function (SMF), Network Repository Function (NRF), Authentication Server Function (AUSF), Unified Data Management (UDM), Network Slice Selection Function (NSSF), Policy Control Function (PCF), N3IWF and User Plane Function (UPF). N3IWF is actually provides a secure gateway to operator's 5G network for non-3GPP access.

This work was supported by Ministry of Information Communications Indonesia.

Hasanah Putri is with Telkom University, Indonesia (email: hasanahputri@telkomuniversity.ac.id).

Sinta Novanana is with University Train 4 Best, Indonesia (email: train4best.indonesia@gmail.com).



TABLE I  
 5G OPENSOURCE SOFTWARE SELECTION

Criteria	Free5gc	Magma 1.7.0	Open 5GS
5G SA features	AMF, SMF, NRF, AUSF, UDM, NSSF, PCF, N3IWF and UPF	AMF/SMF/UPF in preliminary state	Good feature coverage, VoNR coded not tested
3GPP compliance	Rel 15, CUPS/SBA support	Non-compliant	Rel16, CUPS/SBA support
Private 5G support	Basic support exists, performance needs to improve	Tuned for fixed wireless, weak on performance/MEC	Dose not scale well
Network slicing	NSSF is fully functioned	No support	No support
ONAP Integration	Aarna/Intel have done some EMCO integration	Initial orchestration of 1.6.0	-
Easy-to-use	Easy to deploy and use	Easy to deploy and use	Easy to deploy and use
GTP Data plane	Kernel Space	-	User space
Language	Golang, C	Golang	C
Extensible to new NGAP message types	Yes	-	No
Database	MongoDB	MongoDB	No

### B. Installation

Before the installation begin, check the specification of implementation environment. The free5gc stage 3 will be used in this LaaS setup and installed in the Virtual Machine (VM). Table II below lists the specification of the free5gc implementation environment that is used.

 TABLE II  
 SPECIFICATION OF IMPLEMENTATION ENVIRONMENT

Description	Specification
<b>Operating System</b>	Ubuntu 20.04 lts
<b>Processor</b>	2 VCPU
<b>Memory</b>	2048 MB
<b>Boot Disk</b>	40GB

For the installation process please find and click the url below the github link and follow the steps provided: <https://github.com/free5gc/free5gc/wiki/Installation> there are four steps to install the LaaS with free5gc opensource solution are (1) Prerequisites, (2) Control Plane Installation, (3) User Plane Installation and (4) WebConsole Installation. The UERANSIM installation should follow the procedure of installation [21].

### C. The Lab Configuration

There are two labs created to have the end-to-end 5G configuration. The 1st lab created is the 5G Core Network (5gc) and the 2nd lab created is the UE and Radio Access Network (ueran) in the similar way of the 5gc installation. The configuration files need to be modified accordingly, in order to have the proper connection in between network functions, core

network, radio access network as well as the UE. Figure 2 shows 5gc Configuration files, and Figure 3 shows UE and RAN Configuration files.

```

-rw-rw-r-- 1 support support 5519 Aug 27 07:24 amfcfg.yaml
-rw-rw-r-- 1 support support 1462 Aug 16 03:15 ausfcfg.yaml
drwxrwxr-x 2 support support 4096 Aug 16 03:15 multiUPF
-rw-rw-r-- 1 support support 3000 Aug 16 03:15 n3iwfcfg.test.yaml
-rw-rw-r-- 1 support support 2994 Aug 16 03:15 n3iwfcfg.yaml
-rw-rw-r-- 1 support support 1195 Aug 16 03:15 nrfcfg.yaml
-rw-rw-r-- 1 support support 23248 Aug 16 03:15 nssfcfg.yaml
-rw-rw-r-- 1 support support 2084 Aug 16 03:15 pcfcfg.yaml
-rw-rw-r-- 1 support support 4184 Aug 27 07:26 smfcfg.yaml
drwxrwxr-x 2 support support 4096 Aug 16 03:15 TLS
-rw-rw-r-- 1 support support 1760 Aug 16 03:15 udmcfg.yaml
-rw-rw-r-- 1 support support 899 Aug 16 03:15 udrfcfg.yaml
-rw-rw-r-- 1 support support 1452 Aug 16 03:15 uerouting.yaml
-rw-rw-r-- 1 support support 1042 Aug 16 03:15 upfcfg.testucl.yaml
-rw-rw-r-- 1 support support 1042 Aug 16 03:15 upfcfg.test.yaml
-rw-rw-r-- 1 support support 1044 Sep 3 07:27 upfcfg.yaml
-rw-rw-r-- 1 support support 490 Aug 16 03:15 webuticfg.yaml
  
```

Fig. 1. Configuration file

```

-rw-rw-r-- 1 support support 794 Aug 27 06:47 custom-gnb.yaml
-rw-rw-r-- 1 support support 1557 Aug 27 06:47 custom-ue.yaml
-rw-rw-r-- 1 support support 803 Aug 27 06:47 free5gc-gnb.yaml
-rw-rw-r-- 1 support support 1578 Aug 27 06:47 free5gc-ue.yaml
-rw-rw-r-- 1 support support 784 Aug 27 06:47 open5gs-gnb.yaml
-rw-rw-r-- 1 support support 1536 Aug 27 06:47 open5gs-ue.yaml
  
```

Fig. 2. UE and RAN configuration file

The Network function configuration is the end-to-end 5G network setup. The practical exercises itself could be started from the introduction to the troubleshooting tools such as tcpdump, ss, ip and ping commands.

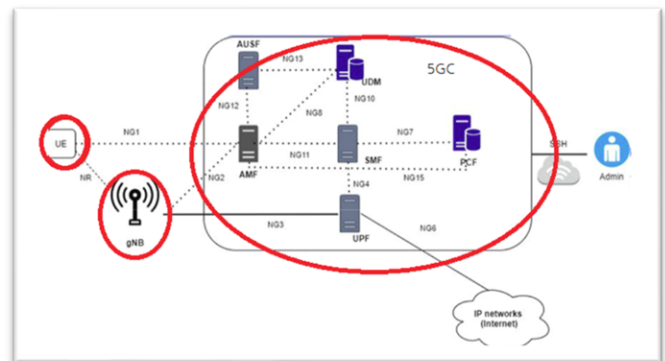

Fig. 3. Lab configuration setup

In the Lab configuration there are UE, gnb and complete 5gc network functions which can be used as the end-to-end simulation for the practical exercises. The network elements available in the Lab configuration [21]: First, Access and Mobility Management Function (AMF). The AMF has the Non-Access Stratum (NAS) Signaling termination functions. This NAS signaling is used in Ciphering and integrity protection, registration management, authentication, authorization, security management, mobility management and connection management. Second, Session Management Function (SMF). The SMF is responsible to provide the UE IP address, using the DHCP functionality. Supporting the session management for example the session establishment, modification and release. Third, Policy Control Function (PCF). The PCF has part of the PCRF functionality from the EPC world. It supports unified policy framework for policy decisions in the UDR. Fourth, User Plane Function (UPF). The UPF is the one who handles directly the user traffic. It supports the packet routing & forwarding, packet inspection, QoS handling and manage the user traffic to

interconnect to the Data Network (DN). Fifth, Unified Data Management (UDM). It has similar functionalities as HSS from the EPC world. It supports the generation of Authentication and Key Agreement (AKA) credentials, user identification handling, access authorization, and subscriber data subscription. Sixth, Authentication Server Function (AUSF). AUSF functions and the authentication server similar to AUC in 2G/3G network or HSS in 4G network. Seventh, Network Slice Selection Function (NSSF). This entity is responsible to support selecting the Network Slice instances to serve the UE, it determine the allowed NSSAI, the AMF to serve the UE. Eight, Network Repository Function (NRF). It supports the service discovery functions. Ninth, gNodeB (gnb) is the Radio access network in 5G. Tenth, User Equipment is the mobile subscriber in 5G.

#### D. Supporting Tools Installation

To support the practical exercises, especially remotely. The tools need to be installed, The tools used in this lab are the MobaXterm and the Wireshark. The MobaXterm is installed and available to perform the practical exercises remotely from the lab. To install the application kindly please download the followings software from this link: <https://mobaxterm.mobatek.net/download.html> the choices are the Home edition and Professional edition. One of the benefits of having the professional edition is that there is no limitation in the number of IP addresses of remote connection allow to connect to on the other hand for the Home edition the connections is limited to 12 connection only.

The step by step of using MobaXterm are as follow :

1. Enter the IP address that has been given
2. Enter username: ubuntu
3. Make sure port: 22
4. In Advanced SSH settings, check "use private key" and enter the private key (optional, only if given a private key)
5. Click the OK button

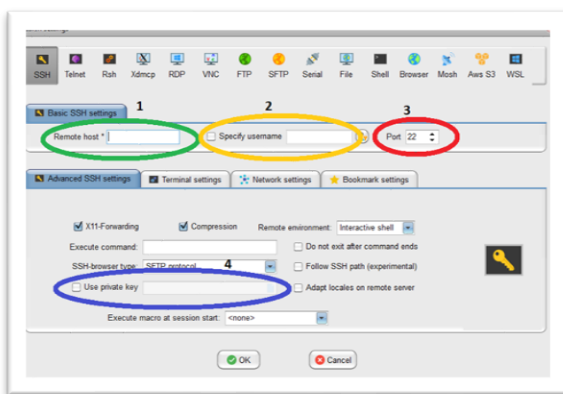

Fig. 4. MobaXterm connection step-by-step

The next supporting tools needed to make the practical exercises possible is the Wireshark. Wireshark is the tools to capture the IP packets from one node to another. It performs the packet sniffing of the related 5G networks. Wireshark does the following :

1. Packet Capture. It listens to a network connection in real time and recorded the entire packet traffics.

2. Filtering. To select the traffic and monitor certain communication the filtering of packets are used. This is very useful for troubleshooting or to learn about the packets (signaling practical exercises in the lab).
3. Visualization. The tracer which is done by Wireshark could be visualized in certain ways that the analysis could be done in a very convenient way and easy to understand even for beginner.

To install wireshark kindly please download the followings software from the link: <https://www.wireshark.org/#download>. The wireshark later on will be used for 5G trace analysis (signaling and user traffic).

### III. THE SCENARIOS FOR LAB

After the two labs are ready then the scenarios of the 5G network end-to-end is become important and crucial. In the beginning of the learning. In this case the 5G learning path, the introduction of 5G has been given and delivered as the theoretical part of the supporting knowledge. The practical hands on exercises are mean to increase the skills of the learner after having fundamental knowledge of 5G networks [22]. The scenarios for the labs could be started with the introduction of general knowledge such as the tools for troubleshooting and the skills to read the result of the tools. In the early part of troubleshooting tools introduction is the usage of tcpdump command.

#### A. Troubleshooting Tools

The troubleshooting tools which will be explained and used are tcpdump, ss, ip and ping. Actually there are more tools such as dig, telnet but not be explained in this paper. tcpdump is a powerful and widely used command-line packets sniffer or package analyzer tool which is used to capture or filter TCP/IP packets that are received or transferred over a network on a specific interface.

1) *tcpdump* is a powerful and widely used command-line packet sniffer or package analyzer tool which is used to capture or filter TCP/IP packets that are received or transferred over a network on a specific interface.

- a. Execute the tcpdump command that captures all the network traffic.
- b. Execute the tcpdump command that captures traffic on a specific network interface.
- c. Execute the tcpdump command that captures traffic of ssh (port 22)
- d. Execute the tcpdump command that captures traffic & saves it to a pcap file



Fig. 5. Tcpdump command line to capture or filter TCP/IP packets

2) *ss command is a tool used to dump socket statistics and display information in similar (simpler and faster) to netstat. Display TCP and state information, ss is the new netstat.*

```
a) ubuntu@t4b-4g1-1635077865355-0:~$ sudo ss -at
b) ubuntu@t4b-4g1-1635077865355-0:~$ sudo ss -au
c) ubuntu@t4b-4g1-1635077865355-0:~$ sudo ss -ant | grep 22
```

Fig. 6. ss command for (a) tcp, (b) udap, and (c) ssh connections

3) *ip command in Linux is present in the net-tools which is used for performing several network administration tasks. This command is used to show or manipulate routing devices and tunnels.*

```
a) ubuntu@t4b-5g1-1637576828367-1:~$ ip -4 a
b) ubuntu@t4b-5g1-1637576828367-1:~$ ip -4 a |grep inet
```

Fig. 7. IP command for (a) IPv4 addresses and (b) Lab's routing table

4) *ping (Packet Internet or Inter-Network Groper) is a basic internet program that allows a user to test and verify if a particular destination IP address exists and can accept requests in computer network administration. The acronym was contrived to match the submariners' term for the sound of a returned sonar pulse.*

```
a) support@5gc2:~$ ping www.google.com
b) support@5gc2:~$ ping 127.0.0.1
c) support@5gc2:~$ ping -c5 www.google.com
```

Fig. 8. Ping command to (a) google, (b) localhost, (c) google 5x

### B. 5G Configuration

Checking the configuration using the files in both labs (5gc and ueran). There are network functions that are need to be checked for each configuration and database could be seen in the Figure 9. The checking will covers not only the IP addresses of each network functions but only to the database related to its functionalities.

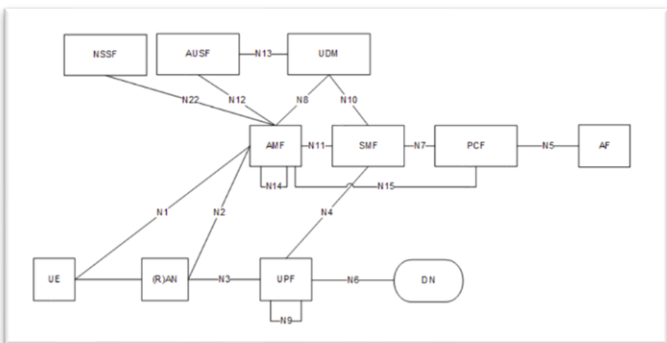

Fig. 9. 5G Network configuration in the laboratory

For example the AMF, it has the IP address and the area to handle the service for the customers. That's why in AMF we need to find out also the AMF ID, and Tracking Area Identity list (TAI list). It could be seen in the Figure 10.

Subscriber administration could be done via WebConsole.  
<IP address 5gc>:5000  
Username : admin  
Password : free5gc

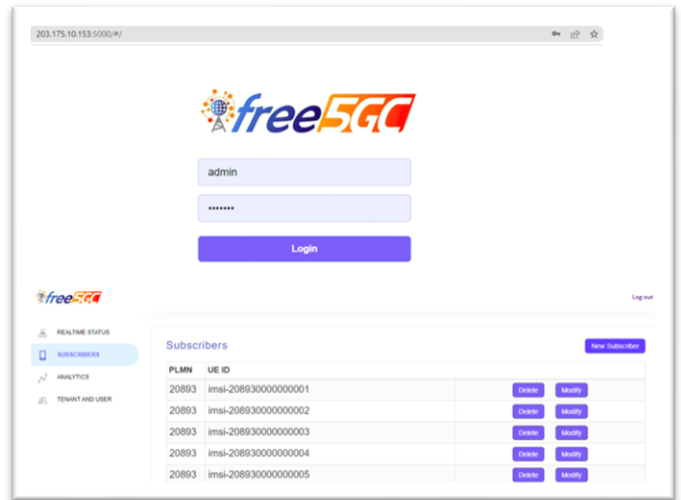

Fig. 10. The subscriber administration via WebConsole

### C. 5GC Activation

For the 5G activation, the status of all networks must be the inactive status (dead) and after, enter the command:

```
support@5gc:~$ sudi systemctl start 5gc
```

Before the activation begin, the tcpdump command and save it to the pcap file is should be done. Figure 11 is the step-by-step of 5gc activation, it shows the network functions activations:

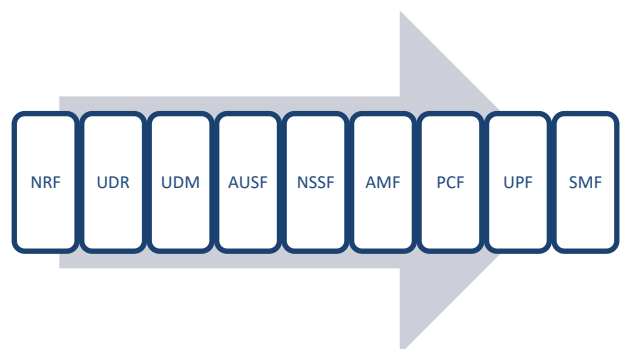

Fig. 11. Step-by-step of 5gc activation

The result could be open via wireshark and the analysis could be delivered based on Table III, pay attention to the protocol as it is used to filter the messages. The part of 5gc activation process could be seen in the Figure 12.

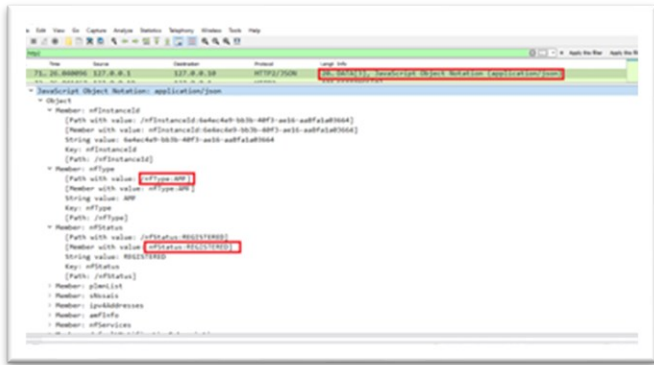

Fig. 12. The part of 5gc activation process

D. 5GC Registration

As the analysis for the 5G traces need to have good foundation on signaling then in the introduction theoretical part, the protocol stacks is given and explain clearly. The user plane and control plane of 5G could be seen in the Figure 13 and 14.

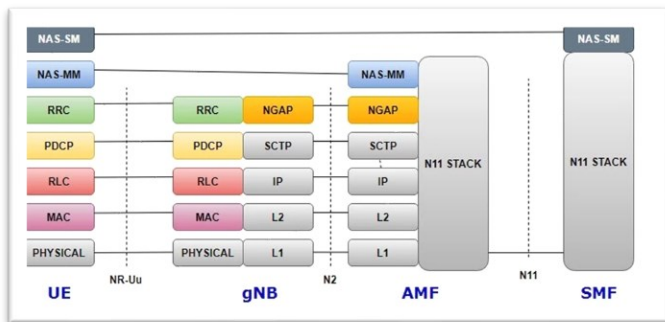

Fig. 13. The control plane of 5G

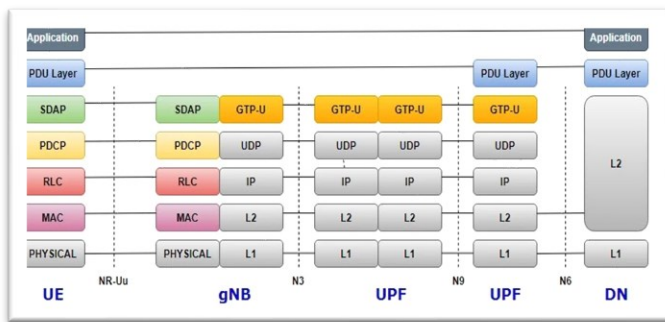

Fig. 14. The user plane of 5G

For the 5G registration procedure, make sure that the 5gc is already active where gnb and ue are all in inactive state. Perform sudo tcpdump to a file, start the gnb and ue and then open the file after the capturing finished.

TABLE III  
 THE 5GC ACTIVATION, PROTOCOLS AND ENTITIES

No	Description	Protocol	Entities
1	Initial UE Message	NGAP/NAS-5GS	UE-gNB-AMF
2	Authentication vector request	HTTP2	AMF-AUSF-UDM
3	Authentication/security	NGAP/NAS-5GS	AMF-UE
4	UDM registration/subscriber info retrieval	HTTP2	AMF-UDM
5	Policy association	HTTP2	AMF-PCF
6	Registration accept	NGAP/NAS-5GS	AMF-UE

Figure 15 - 18 below display of the process of 5GC activation, protocols and entities.

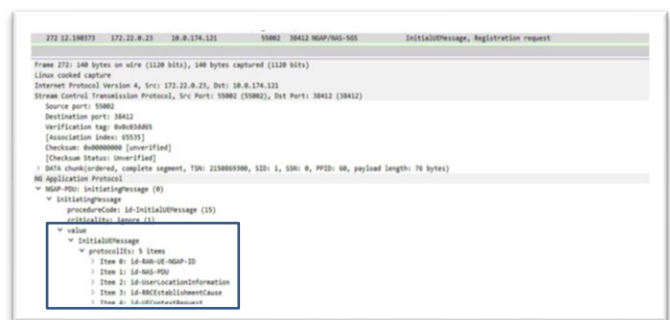

Fig. 15. Initial UE message



Fig. 16. Authentication vector request

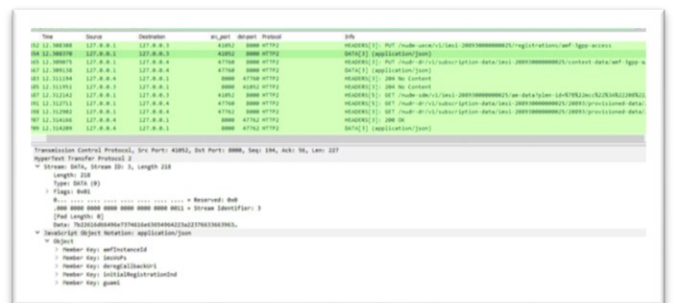

Fig. 17. UDM registration or subscriber info retrieval

