

## INFLUENCE OF MOLDING MATERIALS ON THE SELF-HARDENING OF X46Cr13 STEEL / GREY CAST IRON BIMETALLIC CASTINGS

The paper presents the problem which concerning the technology of bimetallic castings in materials configuration: high-chromium steel as the working layer and grey cast iron as the base part. The aim of the studies was integrate the process of manufacturing of bimetallic casting with the heat treatment of hardening type of X46Cr13 steel insert by applying the mould with sandmix on a matrix of chromite sand. Range of studies included the chemical composition analysis, non-destructive ultrasonic tests to examine the quality of the permanent bond between the working layer (steel insert) and the base part (grey cast iron) of the bimetallic castings, hardness measurements as well as metallographic examinations performed on the optical and scanning electron microscopes. On the basis of obtained results was concluded that the self-hardening process occurred in the X46Cr 13 steel working layer and in result of this the hardness on its surface equalled approx. 45HRC in case of the bimetallic castings with full permanent bond between both parts.

*Keywords:* Bimetallic casting, Grey cast iron, Tool steel, Hardness, Microstructure

### 1. Introduction

The technology of layered castings becomes more and more popular in many fields of the industry. Its main feature is the possibility of combining two materials differing in usable properties and utilize, at the same time, advantages of each of them. This technology is important when the construction element is not exposed in entire volume on the impact of destructive external factors, and therefore when application of the material that meets the requirements of high usable properties seems not to be reasonable because of its high price and low availability. This is the reason why, in the technology of layered castings also called bimetallic castings, as a surface working layer, being in contact with the external factors, is usually used the wear resistant material, while the base part, fulfilling only the function of supporting structure and is made from common casting material as cast iron or cast steel.

In papers [1-12] are presented in details the most popular technology of bimetallic castings in liquid-solid system based on the method of mould cavity preparation by specified insert. The idea of this technology is based on obtaining of layered element as a result of placing a properly prepared insert in the mould cavity directly before liquid alloy pouring most often grey cast iron or unalloyed cast steel. The insert can be used in

various forms, for example are used granular inserts on the base of Fe-Cr-C alloys [3], Al<sub>2</sub>O<sub>3</sub> [4] or TiC [5], monolithic inserts as plates from unalloyed steel [6-8] or tool steels [2,9-11], and the newest 3D printed spatial inserts of Ti [12]. As shown in paper [2] the most important parameters of creation the quality of diffusion bond and therefore the usefulness of the layered casting in this technology are chemical compositions and thickness ratio of connected bimetal parts and temperature of insert heating which depends among others on pouring temperature of liquid alloy filling the mould. Moreover the last of these parameters i.e. temperature of insert heating strongly impacts on microstructure and in result of this on usable properties of surface working layer of bimetallic casting. According to paper [2] in case of using as inserts the austenitic chromium-nickel steel or high-chromium ferritic steel, theirs heating and next cooling in the mould constitute the heat treatment of annealing type which consolidates the austenitic or ferritic microstructure in the surface of working layer of bimetallic casting. Therefore this process does not affect negative on the assumed usable properties of the surface working layer of bimetallic casting. However as shown also in paper [2] in case of using as inserts the ferritic-austenitic duplex steel or quenched low-alloy steel, theirs heating and next cooling in the mould in the first of them leads to precipitation of brittle intermetallic phase  $\sigma$  or leads to

<sup>1</sup> SILESIAAN UNIVERSITY OF TECHNOLOGY, DEPARTMENT OF FOUNDRY ENGINEERING, 7 TOWAROWA STR., 44-100 GLIWICE, POLAND

\* Corresponding author: natalia.przyszlak@polsl.pl

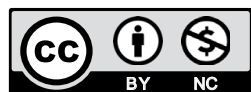

high tempering of martensite in the second of them. As a result, there is a significant reduction in usable properties of the surface working layer of bimetallic casting.

Whereas in presented studies which are continuation of researches from paper [11] is shown possibility of positive use of the heating and next cooling in the mould process to trigger the phenomenon of self-hardening of the high-chromium alloy steel insert. Therefore the aim of studies was integrate the process of manufacturing of bimetallic casting with the heat treatment of hardening type of X46Cr 13 steel insert.

## 2. Materials and methods

In range of studies were made 9 bimetallic casting in materials configuration: high-chromium tool steel X46Cr 13 grade used as insert and as a result being a working layer of the bimetal and grey cast iron EN-GJL-HB 255 grade used as alloy which filling the mould and as a result being a base part of the bimetal. The chemical composition of both alloys measured by the optical emission spectrometer LECO GDS500A is presented in Table 1.

In Fig. 1 is presented scheme of the example distribution of inserts and the rest parts of castings together with the gating system. In the experiment for bimetallic castings made, two-part sand moulds were used. The sandmix on a matrix of silica sand was used to made the upper part of the mould. Whereas to made

the bottom part of the mould, in which the insert was placed, was used the sandmix on a matrix of chromite sand (AFS 45/50) which has higher thermal conductivity comparing to silica sand, ( $\lambda_{\text{silica sand}} = 0,9 \text{ W/mK}$ ,  $\lambda_{\text{chromite sand}} = 1,3 \text{ W/mK}$ , at  $T = 20^\circ\text{C}$ ) [13]. In both sandmixs as binder was used  $\text{CO}_2$  hardened resin Carbophen 9026. Quantitative proportion of the ingredients was: 1 part of Carbophen 9026 for 30 parts of sandmix.

The contact area of insert, in a form of 5 mm thick plate of X46Cr 13 steel, was properly prepared before the placement in the mould cavity according to the procedure presented in paper [2]. In details preparatory activities included sandblasting and application of fluxing agent based on boron and sodium, which favours to obtain permanent bond between the insert and the base part.

As the variable factors of cast process were thickness of the base part and the pouring temperature of cast iron. The grey cast iron base part thickness (g) amounted 20, 40 and 60 mm. Therefore, thickness ratio of the working layer to the base part amount: 1:4, 1:8 and 1:12, respectively. While the rest dimensions i.e. width and length were constant for all layered castings and equal  $50 \times 50 \text{ mm}$ . The pouring temperature ( $T_p$ ) of cast iron was 1400, 1450 and  $1500^\circ\text{C}$ . Full experimental plan in Table 2 is presented.

The temperature of steel inserts during pouring and cooling in the mould was register using Crystaldigraph M24 and thermoelements Pt-PtRh10. These thermoelements were placed in a bottom part of the mould, in thermal centre on external surface of the insert.

TABLE 1

Chemical composition of steel X46Cr 13 grade and grey cast iron EN-GJL-HB 255 grade

wt. %										
C	Cr	Ni	Mo	Mn	Si	Al	Cu	V	S	P
<b>X46Cr 13</b>										
0.430	13.600	0.125	0.015	0.610	0.383	0.003	0.069	0.099	0.002	0.025
<b>EN-GJL-HB 255</b>										
3.550	0.123	0.058	0.011	0.450	2.150	0.004	0.071	0.048	0.100	0.260

TABLE 2

Experimental plan

No. of layered casting	1	2	3	4	5	6	7	8	9
$T_p, ^\circ\text{C}$	1400			1450			1500		
g, mm	20	40	60	20	40	60	20	40	60

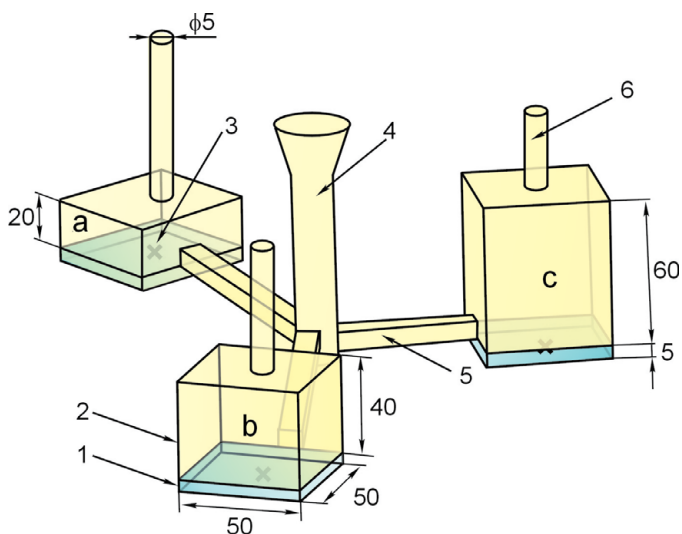

Fig. 1. Example scheme of studied bimetallic castings with gating system: 1 – steel insert, 2 – grey cast iron base part, 3 – thermoelement, 4 – sprue, 5 – in-gate, 6 – overflow

The efficiency of the bond between the working layer and the base part of bimetal i.e. between high-chromium tool steel and grey cast iron was investigated on Starmans Electronics DIO 1000 defectoscope.

In aim to determine hardness of the steel working layers of the bimetallic castings were applied HRC scale using SUNPOC SBRV-100D and FUTURE-TECH FM 700 hardness testers. Hardness was measured on the surface of steel insert, in 16 evenly distributed points, according the scheme in Fig. 2 and on cross-section starting from the thermal center of surface of the working layer (first measurement was made at the distance

of 0,25 mm from the surface) in direction to the base part, in steps of 0,5 mm.

The metallographic researches were made with use of optical microscope (OM) Nikon Eclipse LV150N and scanning electron microscope (SEM) Phenom ProX with an energy X-ray dispersive spectrometer. Metallographic samples were etched using the reagent Mi19Fe contained 3 g of ferric chloride, 10 cm<sup>3</sup> hydrochloric acid and 90 cm<sup>3</sup> ethanol.

### 3. Results and discussion

In conducted studies was search connection between two basic criterions of analyzed layered castings usability i.e. obtaining highest possible cooling rate of steel plate insert (guaranteeing the phenomenon of self-hardening of X46Cr 13 steel and increase in its hardness) and good quality of permanent bond between the working layer and the base part. Therefore as shown in Fig. 3 in studies was analyzed process of heating and cooling

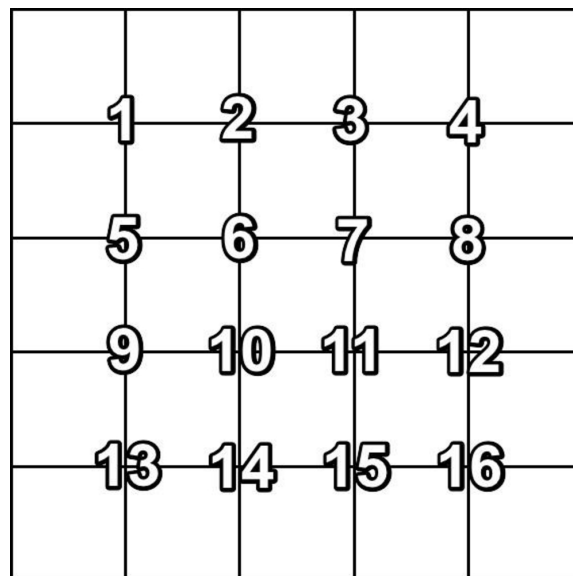

Fig. 2. Scheme of hardness measurements on the surface of X46Cr 13 steel part of bimetallic casting

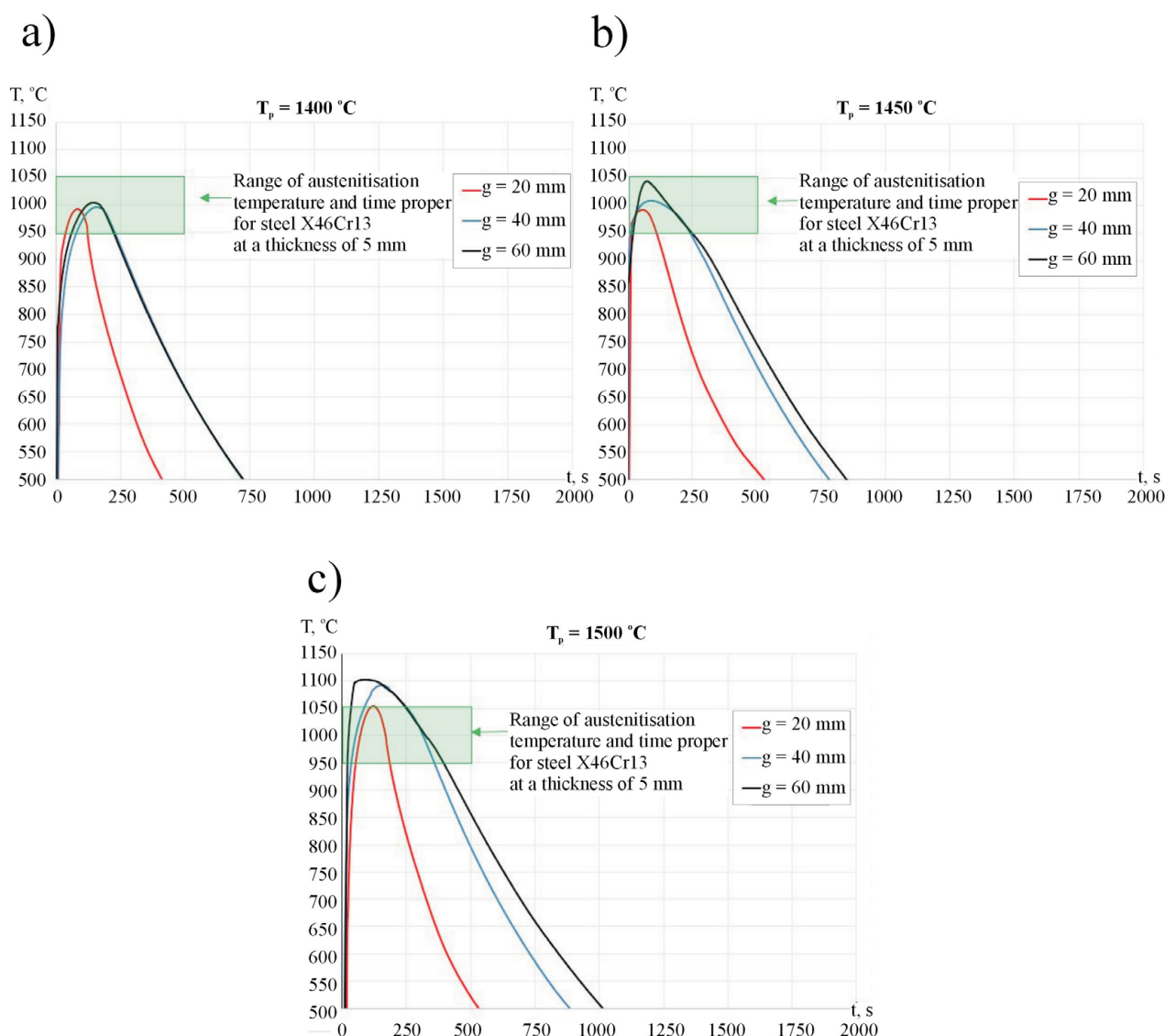

Fig. 3. Characteristic curves  $T = f(t)$  for the external surface of X46Cr 13 steel inserts in dependence on thickness of the grey cast iron base part ( $g$ ) and its pouring temperature ( $T_p$ ): a) 1400°C, b) 1450°C, c) 1500°C

of steel insert in the mould. For considered problem important is achievement the temperature and time of austenitization of steel X46Cr 13 grade. As mentioned in paper [14] the proper range of austenitization temperature for this steel is from 950 to 1050°C. Whereas the proper time of austenitization for plate of thickness 5 mm equals approx. 450 s. As it is seen in Fig. 3 and Tab. 3, the lower limit of austenitization temperature for X46Cr 13 steel was reached on external surface of the working part in all studied layered castings. Whereas the upper limit of austenitization temperature was reached only on external surface of the steel working part for castings when the pouring temperature of cast iron equaled 1500°C, regardless of thickness of the base part of bimetal.

TABLE 3

Selected parameters of the heating and cooling process of X46Cr 13 steel insert in the mould poured with cast iron

No. of layered casting	1	2	3	4	5	6	7	8	9
$T_{max}, ^\circ\text{C}$	993	996	1003	993	1010	1044	1054	1092	1103
$V_{8/5}, ^\circ\text{C/s}$	1.5	0.9	0.8	1.1	0.8	0.7	1.4	0.8	0.7

Additionally based on recorded curves  $T = f(t)$  were calculated cooling rate  $V_{8/5}$  on external surface of the steel working part i.e. cooling rate in the range of temperature from 800 to 500°C (Tab. 3). According to the analysis of TTT diagram of X46Cr 13 steel which is presented in paper [15], this range of temperature is key to the matrix type of Cr(Fe) carbides in microstructure. Increase in this cooling rate guarantees obtaining high as possible amount of martensite and low as possible amount of pearlite. The value of  $V_{8/5}$  depends mainly on thickness of the base part of layered casting i.e. decreases with increase of thickness of grey cast iron part. Moreover, in contrast to the influence of thickness of the base part, it not found essential impact of the pouring temperature of cast iron on above mentioned cooling rate.

Whereas, permanent bond on entire contact surface, which would be desirable in point of view of usability of bimetal, was achieved only for layered castings where thickness of grey cast iron part was 60 mm (Fig. 4).

As it is seen in Fig. 5, at given pouring temperature of the cast iron, the highest hardness on surface of the steel working layer was achieved at the lowest thickness of the base part.

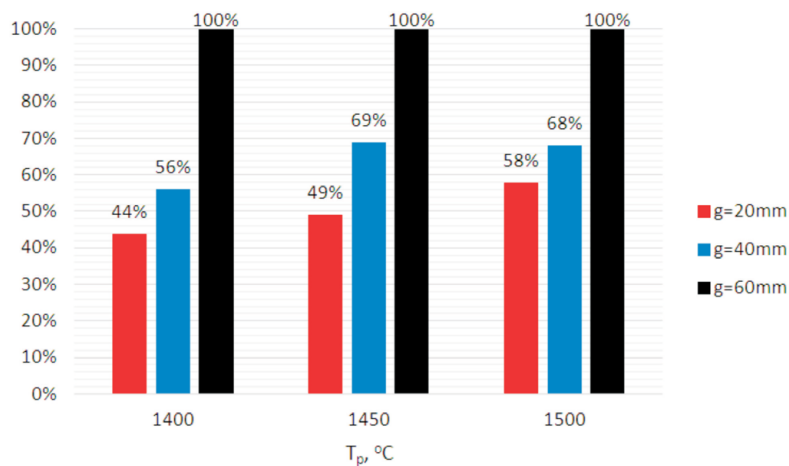

Fig. 4. The influence of thickness of the grey cast iron base part (g) and pouring temperature ( $T_p$ ) on area fraction of permanent bond between both parts of layered casting

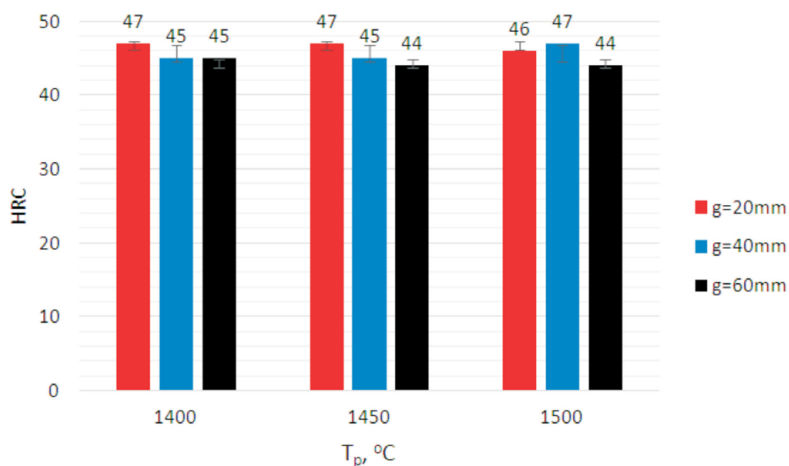

Fig. 5. The influence of thickness of the grey cast iron base part (g) and pouring temperature ( $T_p$ ) on hardness of surface of the working layer of bimetallic casting

Therefore the unequivocal impact of cooling rate  $V_{8/5}$  on hardness of X46Cr 13 steel working layer of bimetal has been demonstrated, because as mentioned above exists strongly relationship between values of  $g$  and  $V_{8/5}$ . Moreover as concluded earlier because the value of  $T_p$  does not strongly affect on value  $V_{8/5}$ , its impact on hardness of X46Cr 13 steel working layer of bimetal is also low.

Whereas, the results of microhardness measurements, presented in Fig. 6, show that in all layered castings in the entire volume of the steel insert a hardening process with a fairly regular course took place. Therefore was concluded that, it is sufficient to exceed the lower limit of austenitization temperature equals  $950^\circ\text{C}$  to harden the steel working layer in presented technology of the layered castings. In addition, probably due to the low dynamics of the process in created conditions, to harden the external surface of the steel working layer of bimetal the time shorter than 450 s (required for 5 mm thick steel plate) is sufficient.

The hardening of X46Cr 13 steel working lets obtain the hardness increase to the level approx.  $45\div 50\text{HRC}$  occurring up to the depth approx. 4.5 mm from the surface. It results from obtaining in this area the microstructure contains very fine Cr (Fe) carbides in martensitic matrix (Fig. 7 and Tab. 4). Due to the existing limitations with respect to the accuracy of energy

dispersive X-ray spectroscopy (EDS) analysis, when determining primarily C concentration as shown in paper [16], as well as inaccuracy of measurements resulted both from contamination of the sample and origin of studied signal simultaneously from selected very fine  $M_xC_y$  phase and also from surrounding matrix, it is difficult to determine on the basis of the obtained results the type of these Cr (Fe) carbides. However, based on the results presented in papers [17-19] in this grade of tool steel after hardening are present in martensitic matrix mainly  $M_{23}C_6$  carbides. Moreover in studied microstructure is present pearlite in small amount. The presence of this phase in microstructure of studied X46Cr 13 steel, close to carbides and martensite, as mentioned above, is predicted also on the basis of its TTT diagram at low cooling rate, as shown in paper [15]. The amount of hardness-reducing pearlite in the microstructure of analyzed steel working layers of bimetals does not exceed approx. 5.5% and decreases with decrease in cast iron pouring temperature and thickness of the base part.

Moreover increasing of hardness at the depth of steel working part above 4.5 mm from the surface results from presence in pearlite matrix of large amount of Cr(Fe) carbides (Fig. 8, 9 and Tab. 4). According to [2,10] this zone arises from the liquid phase in carburized area of the bond between both components

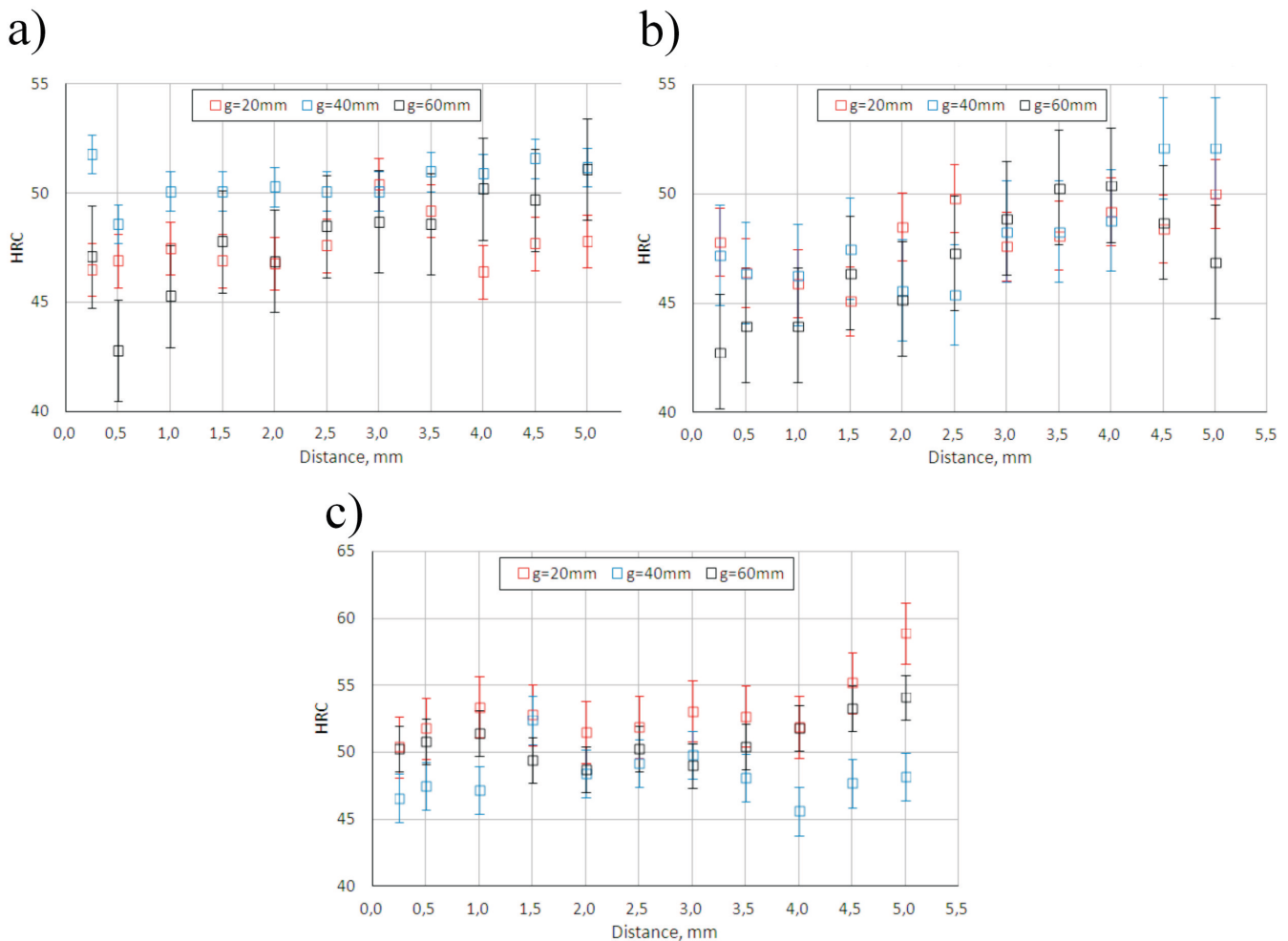

Fig. 6. Distribution of hardness on cross-section of the X46Cr13 steel working layer of bimetallic casting: a)  $T_p = 1400^\circ\text{C}$ , b)  $T_p = 1450^\circ\text{C}$  and c)  $T_p = 1500^\circ\text{C}$

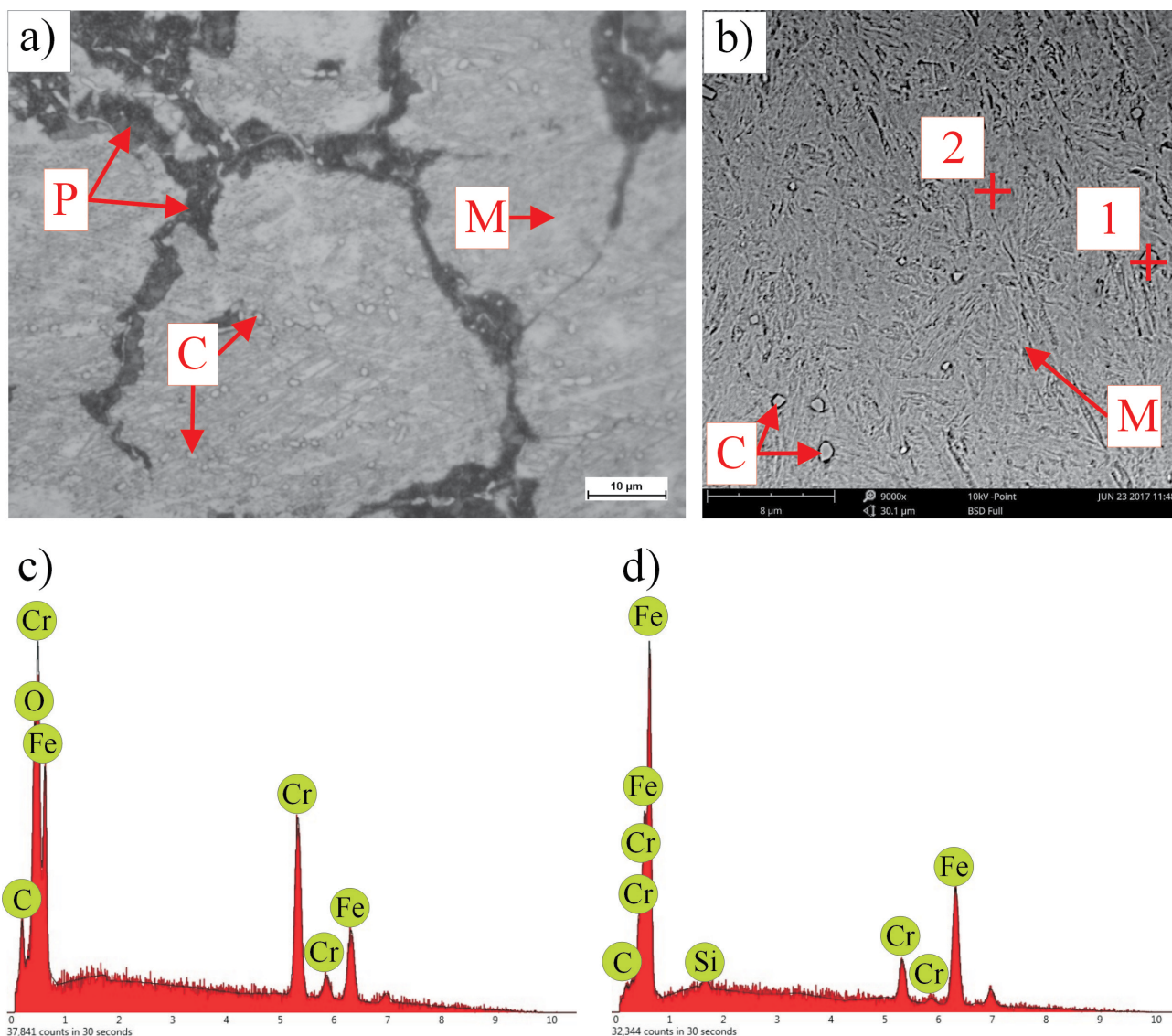

Fig. 7. Example microstructure of the working layer of the bimetallic casting X46Cr 13 steel – grey cast iron; Cr (Fe) carbides (C), martensite (M) and pearlite (P): a) OM, mag. 1000 $\times$ , b) SEM, mag. 9000 $\times$ ; 1 and 2 as points of EDS analysis, c) the result of EDS in point 1 from Fig. b and d) the result of EDS in point 2 from Fig. b

TABLE 4

The results of EDS analysis in points 1, 2 from Fig. 7b and 1 from Fig. 9a

No. of point	Element	at. %	at. % error	wt. %	wt. % error
1 from Fig. 7b	Cr	34.4	$\pm 0.7$	44.6	$\pm 0.9$
	Fe	30.7	$\pm 0.9$	42.9	$\pm 1.3$
	O	20.5	$\pm 0.4$	8.2	$\pm 0.2$
	C	14.4	$\pm 1.2$	4.3	$\pm 0.3$
2 from Fig. 7b	Fe	75.0	$\pm 1.5$	84.0	$\pm 1.7$
	Cr	11.1	$\pm 0.4$	11.5	$\pm 0.5$
	O	10.3	$\pm 0.4$	3.3	$\pm 0.1$
	C	2.8	$\pm 1.0$	0.7	$\pm 0.3$
	Si	0.8	$\pm 0.1$	0.5	$\pm 0.1$
1 from Fig. 9a	Fe	36.2	$\pm 0.7$	55.4	$\pm 1.1$
	Cr	20.0	$\pm 0.4$	28.5	$\pm 0.6$
	C	28.6	$\pm 0.9$	9.4	$\pm 0.3$
	O	15.2	$\pm 0.3$	6.7	$\pm 0.1$

of bimetallic casting and besides pearlite matrix contains mainly  $M_7C_3$  carbides. In particularly as show results obtained in papers [2,6,7,9-11] the presence of this zone decides about the durability of the bond between steel and cast iron in bimetallic castings made with the use of the liquid-solid method. Additionally, the creation of this bonding zone according to the mechanism of heat and mass transport is described also in detail in paper [2].

Comparing the obtained results with those presented in the previous studies of paper authors which was published as [11], it should be stated that application of sandmix on a matrix of sand with a higher thermal conductivity coefficient i.e. chromite sand in presented researches in place of silica sand in [11], guarantees increase in hardness of surface of the X46Cr 13 steel working layer from approx. 35HRC to 45HRC for layered castings with permanent bond on entire contact surface between high-chromium steel and grey cast iron i.e. in both cases for thickness of the base part equalled 60mm regardless of used pouring temperature.

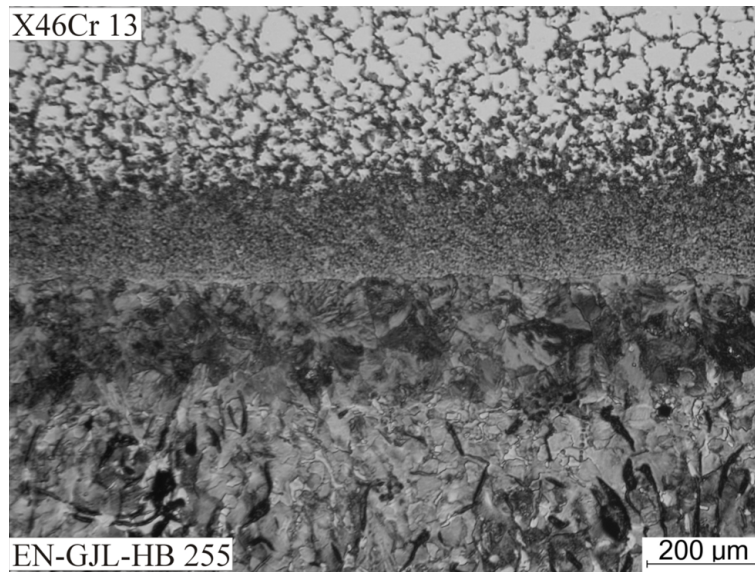

Fig. 8. Example multi-zones microstructure of the bimetallic casting X46Cr 13 steel – grey cast iron; OM, mag. 50×

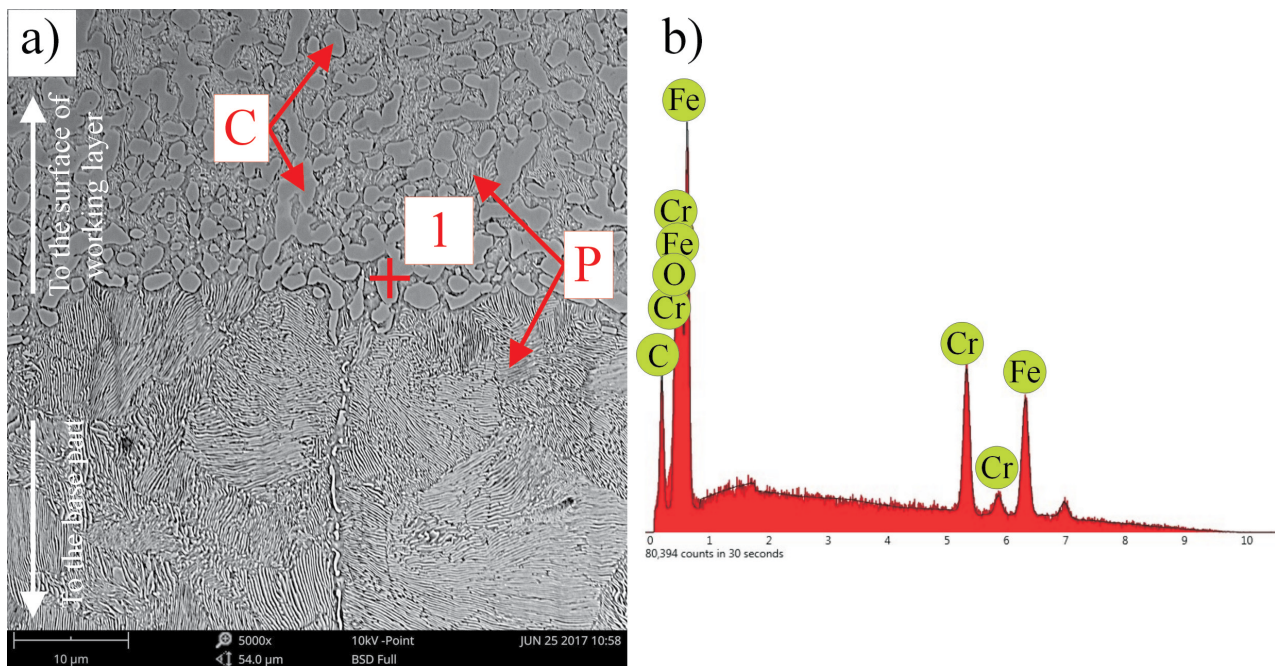

Fig. 9. Example microstructure of the bonding zone in the bimetallic casting X46Cr 13 steel – grey cast iron; Cr (Fe) carbides (C) and pearlite (P): a) SEM, mag. 5000×; 1 as point of EDS analysis, b) the result of EDS in point 1 from Fig. a

#### 4. Conclusions

Base on conducted studies following conclusion have been formulated:

1. Presented technology of layered castings make possible to integrate the heat treatment of hardening type of X46Cr 13 steel with cast process of grey cast iron in bimetallic system.
2. The thickness of the base part is a parameters which strongly affects on usability of the layered casting X46Cr 13 steel – grey cast iron than the pouring temperature.
3. Application of the mould on chromite sand matrix to made the bimetallic casting in configuration X46Cr 13 steel with

grey cast iron lets obtain hardness of the surface of working layer up to 45 HRC at permanent bond on entire contact surface between both components.

#### REFERENCES

- [1] Z. Górný, Reinforced and multilayer castings. Solidification of Metals and Alloys **11**, 135-164 (1987), in Polish.
- [2] T. Wróbel, Layered castings made by method of mould cavity preparation with monolithic insert, Archives of Foundry Engineering, Katowice – Gliwice (2016), in Polish.

- [3] J. Szajnar, A. Dulaska, T. Wróbel, J. Suchoń, Diffusion of C and Cr during creation of surface layer on cast steel casting, *Arch. Metall. Mater.* **59** (3), 1085-1087 (2014). DOI: 0.2478/amm-2014-0186
- [4] A. Dulaska, A. Studnicki, J. Szajnar, Reinforcing cast iron with composite insert, *Arch. Metall. Mater.* **62** (1), 365-367 (2017). DOI: 10.1515/amm-2017-0054
- [5] S. Sobula, E. Olejnik, T. Tokarski, Wear resistance of tic reinforced cast steel matrix composite, *Arch. Foundry Eng.* **17** (1), 143-146 (2017). DOI: 10.1515/afe-2017-0026
- [6] X. Zhi, Y. Han, J. Liu, M. Zhao, S. Ma, Casting process optimization of a bimetal wear-resistant block using liquid-solid processing, *Int. J. Mater. Res.* **105** (10), 953-960 (2014). DOI: 10.3139/146.111109
- [7] V. Javaheri, H. Rastegari, M. Naseri, Fabrication of plain carbon steel / high chromium white cast iron bimetal by liquid-solid composite casting process, *Int. J. Min. Met. Mater.* **22** (9), 950-955 (2015). DOI: 10.1007/s12613-015-1154-3
- [8] M. Ramadan, B. Ayadi, W. Rajhi, A. Alghamdi, Influence of tinning material on interfacial microstructures and mechanical properties of Al12Sn4Si1Cu /carbon steel bimetallic castings for bearing applications, *Key. Eng. Mater.* **835**, 108-114 (2020). DOI: 10.4028/www.scientific.net/KEM.835.108
- [9] C. Cingi, V. Rauta, E. Niani, J. Orkas, Cast bonding of cast irons to ferritic stainless steel, *Mater. Sci. Forum.* **654-656**, 2712-2715 (2010). DOI: 10.4028/www.scientific.net/MSF.654-656.2712
- [10] M. Ramadan, Interface characterization of bimetallic casting with a 304 stainless steel surface layer and a gray cast iron base, *Adv. Mat. Res.* **1120-1121**, 993-997 (2015). DOI: 10.4028/www.scientific.net/KEM.835.108
- [11] N. Przyszlak, T. Wróbel, Self-hardening of X46Cr13 steel integrated with base from grey cast iron in bimetallic system, *Arch. Foundry Eng.* **19** (2), 29-34 (2019), DOI: 10.24425/afe.2019.127112
- [12] T. Wróbel, N. Przyszlak, A. Dulaska, Technology of alloy layers on surface of castings, *Int. J. Metalcast.* **13** (3), 604-610 (2019). DOI: 10.1007/s40962-018-00304-x
- [13] MagmaSoft v5.4 Database.
- [14] J. Adamczyk, Engineering of metallic materials, Silesian University of Technology, Gliwice (2004), in Polish.
- [15] Characteristic of steels, Krupp Stahl AG, 4.300, 86-87 (1982).
- [16] A. Wassilikowska, A. Czaplicka-Kotas, M. Zielina, A. Bielski, An analysis of the elemental composition of micro-samples using EDS technique, *Technical Transactions Chemistry* **18** (1), 133-148 (2014).
- [17] C. Garcia de Andres, G. Caruana, L. Alvarez, Control of  $M_{23}C_6$  carbides in 0.45C-13Cr martensitic stainless steel by means of three representative heat treatment parameters, *Mater. Sci. Eng.* **241** (1-2), 211-215 (1998). DOI: 10.1016/S0921-5093(97)00491-7.
- [18] P. Rosemann, N. Kauss, C. Muller, T. Halle, Influence of solution annealing temperature and cooling medium on microstructure, hardness and corrosion resistance of martensitic stainless steel X46Cr13, *Mater. Corros.* **66** (10), 1068-1076 (2015). DOI:10.1002/maco.201408081
- [19] Y. Yang, H. Zhao, H. Dong, Carbide evolution in high-carbon martensitic stainless cutlery steels during austenitizing, *J. Mater. Eng. Perform.* **29** (6), 3868-3875 (2020). DOI: 10.1007/s11665-020-04912-9