

Towards optimal operation control in rural low voltage microgrids

M. PAROL*, Ł. ROKICKI, and R. PAROL

Warsaw University of Technology, Faculty of Electrical Engineering, Pl. Politechniki 1, 00-661 Warsaw, Poland

Abstract. The paper raises the issue of controlling rural low voltage microgrids in an optimal manner. The impact of different criterion functions, related to the amount of energy exchanged with the distribution system operator network, the level of active power losses, the amount of energy generated by different energy sources and the value of financial performance measures regarding the microgrid operation, on the choice of operating points for devices suggested by the optimization algorithm has been analyzed. Both island and synchronous microgrid operation modes are being considered. We propose two variants of the optimization procedure: the first one is based on the particle swarm optimization algorithm and centralized control logic, and the second one takes advantage of the decentralized approach and Monte Carlo methods. A comparison of the simulation results for two sample rural microgrids, obtained for different objective functions, microgrid operation modes and optimization procedure variants, with the use of prepared algorithm implementations, has been provided. The results show that the proper choice of an objective function can have a crucial impact on the optimization algorithm's behavior, the choice of operating points and, as a consequence, on microgrid behavior as well. The choice of the proper form of the objective function is the responsibility of the person in charge of both the microgrid itself and its operation. This paper can contribute towards making correct decisions in this area. Generally, slightly better results have been achieved for the centralized control mode of operation. Nevertheless, the results also suggest that in many cases the approach based on distributed logic can return results that are better or sufficiently close to the ones provided by the centralized and more sophisticated approach.

Key words: microgrids, centralized control, distributed control, rural areas.

1. Introduction

The topic of operation control in microgrids has already been widely discussed in the literature. Different approaches have been proposed, drawing on both centralized and distributed control logic and making use of many different optimization techniques. However, not so many practical implementations of truly independent and autonomously controlled rural microgrids operating in real world conditions are known. Some of the algorithms are being formulated in the papers only theoretically and evaluated in a simplified manner, while their practical, ready-to-use implementations that could be tested under real conditions do not exist or are not ready yet. Additionally, different objective functions are being selected by the authors of concepts, trying to deal with different problems and to target different optimization goals. Some of the proposed approaches can work very effectively in microgrids operating on a specific voltage level or in the case of grids of a specific structure, but they will fail for different conditions. It seems that there is still too little empirical evidence evaluating the performance of some proposed approaches with ready-to-use algorithm implementations that could find practical applications. Such evaluation could be provided by presentation of data collected at working installations or simulation results obtained for sam-

ple rural microgrids, with topologies and assumptions truly reflecting the ones that can be seen in practice.

Progress in the area of microgrids is undeniably related to the earlier progress of distributed generation. Different aspects regarding the processes of designing and operating distributed generation units, as well as connecting the units to the distribution grids via power electronics converters, have been presented among others in [1–4].

Low voltage (LV) microgrids are the autonomous power generation and distribution micro-systems which comprise microsources (MS), electricity storage units (ES) and electricity loads (non-controllable loads – NCLs, and controllable loads – CLs). The loads are connected to the power grid via controllers (power electronics converters). The concept of the microgrid has been presented in many literature sources, among others in [5–10]. A formal definition of microgrids, given in brochure [5], can be found in [6, 7, 10]. Microgrids offer many advantages to customers and electricity utilities. They are also treated as examples of novel distribution grids architecture within the smart grids concept [5–7].

Microgrids can operate in a grid-connected mode with distribution networks of electricity utilities as well as in an isolated (islanded) mode. The issue of LV microgrids operation control has been presented in multiple literature sources, among others in [8–30]. The essential challenge of operation control is the proper setting of operating points for MSs, ESs and CLs.

As regards the control strategy, two types of low voltage microgrids can be distinguished: microgrids containing the microgrid central controller (MGCC) and microgrids without

*e-mail: mirosław.parol@ien.pw.edu.pl

Manuscript submitted 2018-11-20, revised 2019-03-03, initially accepted for publication 2019-03-18, published in August 2019

the central controller, relying with their functioning on the concept of distributed control. Local controllers (LCs) cooperate with the MGCC in the first of the above-mentioned strategies. Control signals (operating points) are determined by MGCC and then transmitted to LCs. In turn, in distributed control each LC makes decisions about its own operating point independently [8–10, 12, 14, 17, 26–28]. In centralized control, three hierarchical levels can be defined: electricity utility level (represented by the distribution system operator and market operator), MGCC level and the local controllers level [8, 9, 12, 17, 27].

It is worth noting that in some papers [24, 25] the issue of model predictive control is being discussed. The problem of controlling the microgrid during its work in the island operation mode is also of massive importance [24, 25, 28]. One of the aspects of the process of controlling the microgrid that is being emphasized is also the problem of controlling the operation of energy storage units [26, 29].

Appropriate adjustment of operation states of all devices installed in a microgrid while meeting a number of constraints is not an easy task. An overview of control, grid integration and energy management strategies in microgrids was presented in [18]. Architecture, realization and application of microgrid control systems on the basis of the IEC 61850 standard are all described in [19]. Authors of [20] have proposed a coordinated control system of battery energy storage (BES) and dispatchable distributed generation (DG) for microgrids on the basis of fuzzy logic.

Another problem is the optimization of combined cooling, heat and power (CCHP) systems. This problem was analyzed by the authors of paper [22]. A model to determine the appropriate size of the CCHP system and auxiliary boiler as well as to optimize its operation was described there. A very interesting approach to finding a solution to the OPF problem in the case of microgrid clusters was described in [23]. The authors of this paper proposed a novel oblivious power routing algorithm to minimize network power losses and to prevent congestions in the analyzed network.

This paper is an extension of previous concept research, carried out in the RIGRID (rural intelligent grid) project [10, 16, 17]. Details on optimal operation control in low voltage microgrids in rural areas functioning on the basis of centralized control logic have been presented in [17]. In turn, the issue of computer implementation of optimal control algorithms in the case of centralized control of LV rural microgrid operation has been shown in [10].

In this paper, we decided to present the approach based on the particle swarm optimization (PSO) algorithm and the Newton-Raphson method of calculating power flows in the case of centralized control. We provide different objective functions that can be used as an optimization goal, which enables us to modify the algorithm behavior in a manner demanded by the grid operator. Each currently selected and applied criterion function can be easily and arbitrarily exchanged for another one belonging to the set without the need to reformulate the whole algorithm. Our set of objective functions includes the ones allowing for minimization/maximization of the amount

of energy imported from/exported to the distribution system operator (DSO) network, minimization of active power losses, maximization/minimization of the amount of energy generated by renewable/non-renewable energy sources, and minimization of total costs or maximization of total profits related to microgrid operation. We take into account that our approach should allow the microgrid to work both in a synchronous and island operation mode. Moreover, we do not want to limit the scope of our considerations to centralized control logic. We also present the distributed logic based version of our approach, by accommodating the cooperative control hierarchy structure and replacing the PSO method with a Monte Carlo-based approach. This way we provide a comprehensive and coherent framework allowing for comparison of the impact of different optimization goals and control logic paradigms on the choice of operating points that are to be applied in devices and on the behavior of the optimization algorithm in general.

We have ready-to-use versions of our algorithms and optimization methods at our disposal that can be implemented under practical conditions. They are the result of our participation in the RIGRID (rural intelligent grid) European project. Taking advantage of this fact, we are able to present the simulation results for any computational example that we decide to analyze. We have decided to formulate two sample topologies of low voltage rural microgrids, one reflecting the installation that could be constructed to provide a typical countryside area with electricity, and one that could deliver electrical energy to a typical neighborhood consisting of individual households. We have intensively tested our approach for both topologies. The obtained results have been presented in this paper. We analyzed the data returned by the algorithms and compared the behavior of the control algorithm when choosing the operating points to be applied in the devices making up the microgrid in the case of different objective functions, microgrid operation modes and control logic paradigms. This way we were able to evaluate the impact of all these factors on the optimization process behavior and on the resulting microgrid configurations.

The structure of the paper is as follows.

First, an introduction to the research problem has been presented and a review of literature sources concerning the subject of the paper has been offered. Then, general characteristics of low voltage microgrids in rural areas have been presented. Next, a description of proposed microgrid control algorithms, including: problem formulation (objective functions, constraints), algorithm of centralized control logic as well as algorithm of distributed control logic, has been presented. In the further part of the paper, some information about the developed computer program acting according to centralized control logic and distributed control logic has been given. Then, a case study including a description of test microgrids, results of optimization calculations obtained with the use of an algorithm of distributed control logic, results of optimization calculations obtained with the use of the centralized control logic algorithm as well as the most important observations noticed after the experiments carried out, has also been presented. At the end of the paper a summary with final conclusions have been provided.

2. General characteristics of low voltage microgrids in rural areas

Very detailed characteristics of different types of microgrids have been presented in [5–7].

As it was presented in these literature sources, two key types of microgrids can be distinguished along with two other related types of electric power micro-systems, applying very similar technology:

- 1) *Customer microgrids* or *true microgrids* (μ grids), which are self-governed micro-systems located usually downstream of a single point of common coupling (PCC).
- 2) *Utility microgrids* or *community microgrids* or *miligrids* (*mgrids*) constituting a segment of the legacy regulated grid.
- 3) *Virtual microgrids* (*vgrids*) containing distributed energy resources located in multiple places, which are coordinated in such a way that they can be presented, from the point of view the main grid, as a single controlled entity.
- 4) *Remote electric power systems* (*rgrids*), which are unable to operate in a grid-connected mode, and which act as separated power systems.

In microgrids, which are connected to the grid of an electricity utility provider or which form part of an electricity utility grid, large-scale integration of distributed energy resources (DER) is possible. The following types of microsources are usually used in microgrids in rural areas: small hydro power plants, small or micro wind turbine-generator sets, photovoltaic panels, power plants based on biomass and biogas as well as reciprocating engines with internal combustion (engine-generator set) [3, 8–10, 12, 17, 25]. Among energy storage units, battery storages are the most popular ones in rural areas. If electric power lines are taken into consideration, overhead lines are usually used. Similarly, MV/LV transformer substations in open-air design constitute a standard.

The microgrids located in rural areas are able to locally satisfy the energy demands of the consumers and at the same time they make it possible to provide system services. During the grid-connected operation mode, they can offer system services such as e.g.: management of limitations concerning branch capacities in MV grids of the DSO as well as providing reactive power and regulation of voltage levels in grid nodes. In turn, in the intended islanded operation mode, the microgrids have an impact on improvement of supply reliability of consumers that are connected to them [17].

3. Description of proposed microgrid control algorithms

3.1. Problem formulation. The proposed algorithms for controlling the operation of LV microgrids are based on the assumption that the structure of a microgrid is known. The input data for the algorithms contain information about the number, location, rated powers, generation capabilities and types of microsources, energy storage and receiving devices as well as arrangement of connections between microgrid nodes (number, type and topol-

ogy of LV power lines) and necessary economic data (price of energy generated in microsources, etc.).

During its operation, microgrid control algorithms will determine operation states for all controlled devices. In the case of energy storage devices, controllable microsources and controllable loads control algorithms will regulate the values of active and reactive power. Controlling the operation of uncontrollable microsources and uncontrollable loads will involve turning them off or allowing them to operate with a natural level of generated or received power (according to weather conditions and consumer power demand).

The process of optimal control of LV microgrids can be considered in the case of a synchronous and island operation mode. It should also be assumed that all components of a microgrid are modelled as three-phase, balanced elements. In order to ensure appropriate values of short-circuit currents (forcing overcurrent protections at the required time) during island operation, the microgrid is equipped with a synchronous generator connected directly to the LV node in the MV/LV transformer substation. Balancing a microgrid in the island operation mode requires the installation of at least one energy storage device. This energy storage device should be equipped with a voltage source inverter to ensure smooth transition from the synchronous to island operation mode. During its operation, control algorithms will not modify the microgrid structure.

Implementation of a centralized control strategy requires the installation of a microgrid central controller (it is recommended to place such a controller in the vicinity of the MV/LV transformer substation) and local controllers for each controlled element of the microgrid.

In the case of distributed control strategy, the microgrid should be equipped with local controllers capable of autonomous decision making. It is also necessary to ensure the installation of a master controller supervising the operation of individual local controllers.

For both centralized and distributed control logic, the authors formulated 7 independent single-criteria optimization tasks (the detailed forms of selected objective functions are provided in section 3.1.1) [10, 17]:

- minimization of the amount of energy imported from the DSO power grid (only for synchronous operation mode),
- maximization of the amount of energy exported to the DSO power grid (only for synchronous operation mode),
- minimization of active power losses in the microgrid,
- maximization of the amount of energy generated in renewable energy microsources,
- minimization of the amount of energy generated in non-renewable energy microsources,
- minimization of the costs associated with operation of the microgrid,
- maximization of the profits associated with operation of the microgrid.

3.1.1. Objective functions. The proposed algorithms for controlling the operation of an LV microgrid are based on the assumption that the structure of the microgrid is known.

Detailed descriptions of some of the objective functions mentioned above are presented below [17]:

1) Minimization of active power losses in the microgrid.

The form of the objective function in the criterion for minimization of active power losses is as follows:

$$F_{obj} = \min(\Delta P) \quad (1)$$

where F_{obj} is the objective function and ΔP is the sum of total active power losses in the microgrid.

2) Maximization of the amount of energy generated in renewable energy microsourses.

In the case of maximizing the amount of energy generated in renewable energy sources, the objective function takes the following form:

$$F_{obj} = \max(A_{MS,RES}) \quad (2)$$

$$A_{MS,RES} = \Sigma P_{MS,RES} / N_{int} \quad (3)$$

where $A_{MS,RES}$ is the energy generated in renewable energy microsourses, $\Sigma P_{MS,RES}$ is the sum of active power generated in renewable energy microsourses and N_{int} is the number of optimization intervals in an hour.

3) Minimization of the costs associated with operation of the microgrid.

In order to minimize the costs associated with operation of the microgrid, the authors have formulated the following objective function:

$$F_{obj} = \min(C_{OPMG}) \quad (4)$$

$$C_{OPMG} = \Sigma C_{f,T} + \Sigma C_{v,T} \quad (5)$$

$$\Sigma C_{f,T} = \Sigma C_{f,MS,T} + \Sigma C_{f,ES,T} + \Sigma C_{f,DSO,T} \quad (6)$$

$$\Sigma C_{v,T} = \Sigma C_{v,MS,T} + \Sigma C_{v,ES,T} + \Sigma C_{v,DSO,T} \quad (7)$$

where C_{OPMG} are the costs associated with operation of the microgrid, $\Sigma C_{f,T}$ is the sum of fixed costs during the optimization period, $\Sigma C_{f,MS,T}$ is the sum of fixed costs associated with the operation of microsourses during the optimization period, $\Sigma C_{f,ES,T}$ is the sum of fixed costs associated with the operation of energy storage devices during the optimization period, $\Sigma C_{f,DSO,T}$ is the sum of fixed costs associated with the possibility of exchange of electrical energy between the microgrid and DSO power grid, $\Sigma C_{v,T}$ is the sum of variable costs during the optimization period, $\Sigma C_{v,MS,T}$ is the sum of variable costs associated with operation of microsourses during the optimization period, $\Sigma C_{v,ES,T}$ is the sum of variable costs associated with operation of energy storage devices during the optimization period, $\Sigma C_{v,DSO,T}$ are variable costs associated with the possibility of exchange of electrical energy between the microgrid and DSO power grid and T is the optimization period.

4) Maximization of the profits associated with operation of the microgrid.

For the last optimization criterion, the objective function takes the following form:

$$F_{obj} = \max(PR_{OPMG}) \quad (8)$$

$$PR_{OPMG} = A_{tot} \cdot p_s - C_{OPMG} \quad (9)$$

where PR_{OPMG} are the profits associated with operation of the microgrid, p_s is the price, per unit, of energy sold to customers, including the DSO power grid, A_{tot} is the total amount of energy sold, and C_{OPMG} are the costs associated with operation of the microgrid.

All necessary power values, used by the optimization software, will be determined by means of computations performed by the power flow calculations module, which is integrated with the optimization software.

3.1.2. Constraints. The proposed algorithms for controlling the operation of the LV microgrid are based on the assumption that the structure of the microgrid is known.

Optimal operation control algorithms must be supplemented with a number of constraints. The set of constraints includes the following restrictions [9]:

- Long-term current-carrying capacity:

$$I_i \leq I_{z,i}, \quad \forall i = 1, 2, \dots, m \quad (10)$$

where I_i is a maximum current in the i^{th} power line, $I_{z,i}$ is a long-term current-carrying capacity of i^{th} power line and m is the number of power lines in the microgrid.

- Permissible nodal voltage levels:

$$U_{min} \leq U_i \leq U_{max}, \quad \forall i \in (G \cup R), \quad (11)$$

where U_{min} is the minimum permissible nodal voltage level, U_i is the voltage level at an i^{th} node, U_{max} is the maximum permissible nodal voltage level, G is the set of generating nodes and R is the set of receiving nodes.

- Rated power of the MV/LV transformer:

$$S_{TR} \leq S_{TR,r} \quad (12)$$

where S_{TR} is the MV/LV transformer maximum load with apparent power and $S_{TR,r}$ is the rated apparent power of the MV/LV transformer.

- Permissible microsourses generation of active and reactive power:

$$P_{MS,i,min} \leq P_{MS,i} \leq P_{MS,i,max} \quad (13)$$

$$Q_{MS,i,min} \leq Q_{MS,i} \leq Q_{MS,i,max} \quad (14)$$

where $P_{MS,i,\min}$ is the minimum permissible active power generation of an i^{th} microsource, $P_{MS,i}$ is a current active power generation of an i^{th} microsource, $P_{MS,i,\max}$ is the maximum permissible active power generation of an i^{th} microsource, $Q_{MS,i,\min}$ is the minimum permissible reactive power generation of an i^{th} microsource, $Q_{MS,i}$ is the current reactive power generation of an i^{th} microsource and $Q_{MS,i,\max}$ is the maximum permissible reactive power generation of an i^{th} microsource.

- Permissible energy storage devices generation/load of active and reactive power:

$$P_{ES,i,\min} \leq P_{ES,i} \leq P_{ES,i,\max} \quad (15)$$

$$Q_{ES,i,\min} \leq Q_{ES,i} \leq Q_{ES,i,\max} \quad (16)$$

where $P_{ES,i,\min}$ is the minimum permissible active power generation/load of an i^{th} energy storage device, $P_{ES,i}$ is the current active power generation/load of an i^{th} energy storage device, $P_{ES,i,\max}$ is the maximum permissible active power generation/load of an i^{th} energy storage device, $Q_{ES,i,\min}$ is the minimum permissible reactive power generation/load of an i^{th} energy storage device, $Q_{ES,i}$ is the current reactive power generation/load of an i^{th} energy storage device and $Q_{ES,i,\max}$ is the maximum permissible reactive power generation/load of an i^{th} energy storage device.

- Permissible level of energy stored in energy storage devices:

$$A_{\min,i} \leq A_i \leq A_{\max,i}, \quad \forall i \in ES \quad (17)$$

where $A_{\min,i}$ is the minimum permissible level of energy stored in an i^{th} energy storage device, A_i is the current energy level stored in an i^{th} energy storage device, $A_{\max,i}$ is the maximum permissible level of energy stored in an i^{th} energy storage device and ES is the set of energy storage devices.

All necessary power, current and voltage values will be determined by means of a power flow calculations module, which is integrated with the optimization software. In the case where any of the constraints will be affected, an objective function will be penalized.

3.2. Centralized control logic algorithm. In the centralized version of our approach, the existence of the following entities, which can perform computations or be responsible for the task of controlling the devices present in the microgrid, is assumed:

- main microgrid controller – MGCC (also known as the master controller – MC),
- local controllers of devices – LCs.

The primary role of the MGCC is to perform optimization calculations and to compute the set of optimal operating points for all the devices making up the microgrid which can be controlled. One of its tasks is also to listen to the signals coming from LCs, informing about the current state and potential

failures of devices they are in charge of. This way it is able to monitor the current state of the whole microgrid and to be aware of any extraordinary events taking place. Once the current state of the microgrid is determined and the new set of optimal operating points is computed, appropriate control signals (brand-new recently computed operating points) need to be sent by the MGCC to LCs. The only role of LCs is to report on the state of the devices they control to the MGCC, together with the information of all the failures that took place, and to listen to the control signals coming from the MGCC and to try to apply the settings demanded (new operating points) on the devices they are in charge of. The exact details on this cooperation scheme between the MGCC and LCs can be found in [10].

The optimization method used by the MGCC to compute the new set of optimal operating points involves the particle swarm optimization algorithm. To check if the solutions proposed by the algorithm do not violate any of the optimization task constraints, the Newton-Raphson method of calculating power flows is used. We assume that such a procedure is valid and can be used for both the island operation mode and synchronous (with the DSO network) operation mode of the microgrid. However, this regards only the situation where we are obligated to determine the set of new operating points for the future (next) optimization time interval, in most cases equal to 15 minutes of time. If we need to recompute the operating points for the current time interval, as a consequence of some serious failures occurring within the microgrid, forcing us to switch to the island operation mode immediately, when the previous operation mode was the synchronous one, we need to take advantage of a faster procedure, giving up the approach based on the PSO algorithm, which can be too time-consuming in some cases. Only this way can we prevent the microgrid against blackout resulting from the unbalance and against protections being activated and turning off the devices. More detailed information on the faster procedure that we have proposed can be found in [10].

From the theoretical point of view, in the PSO algorithm for each particle in the solution space, the following vector and sub-vectors will be defined:

$$\delta = [\delta_{ES}, \delta_{UCM}, \delta_{CM}, \delta_{CL}] \quad (18)$$

$$\delta_{ES} = [P_{ES,1}, Q_{ES,1}, P_{ES,nES}, Q_{ES,nES}] \quad (19)$$

$$\delta_{UCM} = [P_{UCM,1}, Q_{UCM,1}, P_{UCM,nUCM}, Q_{UCM,nUCM}] \quad (20)$$

$$\delta_{CM} = [P_{CM,1}, Q_{CM,1}, P_{CM,nCM}, Q_{CM,nCM}] \quad (21)$$

$$\delta_{CL} = [P_{CL,1}, Q_{CL,1}, P_{CL,nCL}, Q_{CL,nCL}] \quad (22)$$

where δ is the vector that stores operating points for a given solution, δ_{ES} is the vector assigned to ES local controllers, $P_{ES,i}$ is the active power generated/consumed by an i^{th} energy storage device, $Q_{ES,i}$ is the reactive power generated/consumed by an

i^{th} energy storage device, nES is the number of energy storage devices, δ_{UCM} is the vector assigned to UCM local controllers, $P_{UCM,i}$ is the active power generated in an i^{th} uncontrollable microsource, $Q_{UCM,i}$ is the reactive power generated in an i^{th} uncontrollable microsource, $nUCM$ is the number of uncontrollable microsourses, δ_{CM} is the vector assigned to CM local controllers, $P_{CM,i}$ is the active power generated in an i^{th} controllable microsource, $Q_{CM,i}$ is the reactive power generated in an i^{th} controllable microsource, nCM is the number of controllable microsourses, δ_{CL} is the vector assigned to CL local controllers, $P_{CL,i}$ is the active power consumed by an i^{th} controllable load, $Q_{CL,i}$ is the reactive power consumed by an i^{th} controllable load and nCL is the number of controllable loads.

3.3. Distributed control logic algorithm. In the variant of our approach basing on distributed control logic, we introduce some new entities. All the devices that can be controlled are divided into 4 separate groups: energy storages – ESs, controllable loads – CLs, uncontrollable microsourses – UCMs and controllable microsourses – CMs. A special controller is assigned to each group, referred to as the main group controller – MGC. Its role is to represent all the devices belonging to the group in potential interactions with other groups and to coordinate the behavior of all the elements making up the group. This way we introduce a hierarchical structure originating from the approach known in the literature as cooperative control [21]. In our method, MGCs are responsible for computing the new set of operating points for all the devices belonging to the group, assuming that information about all the other operating points is given and delivered by other MGCs. The information about the state of the microgrid and potential failures is still provided by the MGCC, as previously. Once the operating points are calculated by the MGC, LCs of devices composing the group remain responsible for applying them.

Because of the fact that the work of MGCs does not need to be synchronized in any way and they can perform their computations even at the same time, the information provided by them to other MGCs can quickly become outdated. Especially, when taking potential communication delays into consideration. Also changing the current operating points in one group can open and unlock some new improvement possibilities in other groups. As a result, we expect this approach to be an iterative one. That is why we have decided here to give up the relatively time-consuming PSO-based approach in favor of the intelligent Monte Carlo based approach. Each MGC should choose the best possible solution from the randomly drawn set consisting of N candidate ones. Solutions proposed to compose the set should be chosen in such a way that the total range of power generation / consumption capabilities of the group treated as a whole is uniformly covered. Feasibility of the candidate solution (non-violation of optimization constraints) is still checked by the Newton-Raphson method of calculating power flows, as previously.

In the most basic variant of the approach, a number of iterations of the method is announced at the very beginning of the optimization time interval. The solution with the best result for the chosen objective function is the one to be applied. In

the more sophisticated approach, subsequent iterations of the method are being invoked all the time. Two factors are taken into account: the chosen objective function value and distance from the currently applied solution. At the beginning of the optimization time interval, the first one is of greater importance, losing its relative significance in favor of the second one with the passing of time. This way we can introduce the behavior pattern similar to the one known from the simulated annealing approach.

From the theoretical point of view, in the optimization algorithm for each solution in the solution space one of the vectors given in (19–22) will be defined. Once optimization computations are finished, MGCs will send new operation states to local controllers within the groups.

4. Description of developed computer program

4.1. Centralized control logic. To put the solution into practice, we need to provide the proper implementations of two main modules: the one performing the optimization calculations in accordance with the PSO method and the one performing the power flow computations.

The solution vector in the PSO-based computations needs to consist of a sequence of the following variables:

- $P^{0/1}_{ES,i}$ – information if energy storage should be turned on or off, for every energy storage, binary variable;
- $P_{ES,i}$ – level of active power of energy storage if it is turned on, for every energy storage, real variable;
- $P^{0/1}_{UCM,i}$ – information if uncontrollable microsource should be turned on or off, explicitly determining the level of active power of the device, for every uncontrollable microsource, binary variable;
- $P^{0/1}_{CM,i}$ – information if controllable microsource should be turned on or off, for every controllable microsource, binary variable;
- $P_{CM,i}$ – level of active power of controllable microsource if it is turned on, for every controllable microsource, real variable;
- $P_{CL,i}$ – level of active power of controllable load, for every controllable load, real variable.

We make an assumption here that all the devices present in the microgrid work at their nominal $\cos\varphi$ values, which are constant and fixed during the calculations. This way the active power level always determines the reactive power one. Our optimization problem becomes much simpler and the total amount of variables is reduced. The solution space is also reduced, but when we take a closer look at it, we can see that we do not sacrifice a lot here.

For the whole method to work properly, we also need to transform all the objective functions implying maximization problems into forms allowing to deal only with the minimization ones. Last but not least, solutions violating optimization constraints should be perceived by the optimization algorithm to be distinctly worse than they really are. We can achieve this by introducing the mechanism of penalty functions.

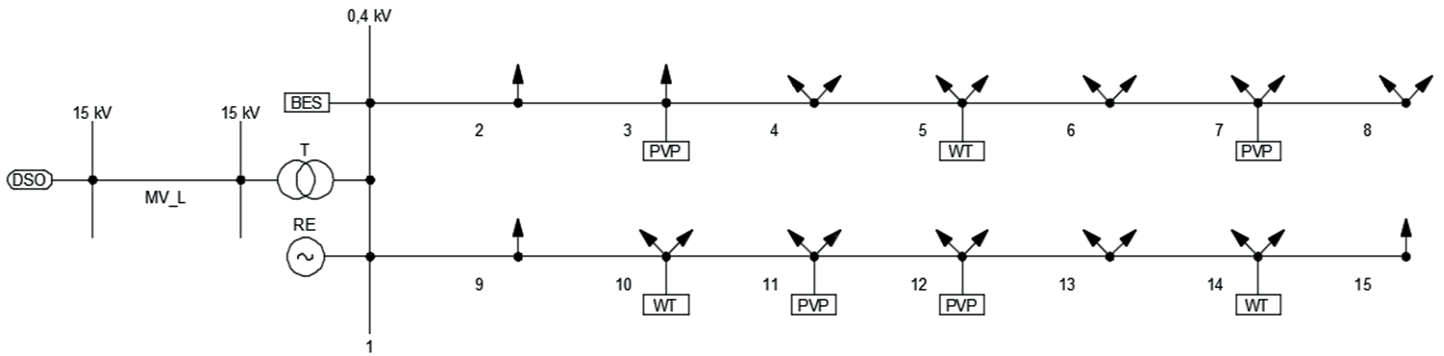

Fig. 1. Key diagram of the LV microgrid in a typical countryside area (PVP – photovoltaic panels, BES – battery energy storage, WT – wind turbine-generator set, RE (SG) – reciprocating engine with internal combustion (engine-generator set))

4.2. Distributed control logic. In the case of distributed calculations, we need to replace implementation of the PSO module with implementation of the intelligent Monte Carlo search module. The form of the solution vector remains the same, however, this time it is limited only to the variables related to the group of devices for which the particular MGC performs computations. Values for all the other variables are treated as fixed and given *a priori*. Optimization constraints are checked and respected the same way as previously (the combination of power flow calculations and penalty functions).

The assumption related to fixed values of the $\cos\varphi$ factors, which can be given up easily, if needed, in the case of centralized version of our approach, is of much greater importance in the distributed version of method. Thanks to it, we can perceive our optimization problem as a one-dimensional one and the total range of power generation/consumption capabilities of the group of devices treated as a whole can be densely, uniformly and fully covered with the use of a relatively small set of candidate solutions.

5. Case study

5.1. Description of test microgrids. In order to verify proper operation of the proposed optimal control algorithms, two test microgrids were prepared. The first one was a microgrid located in a typical countryside area with two radial LV power lines (see Fig. 1). Total length of each power line (from the MV/LV substation to the furthest load) equals 360 meters. The LV power lines are constructed with the use of conductors of the AsXS_n 4×70 mm² type.

Power loads connected to these power lines represent farms and public utility buildings (PUBs). Active power peak loads vary from 2 to 5 kW while all 24 loads operate with a power factor equal to 0.93. Two of these loads (PUBs) are controllable ones with a range from 4 to 6 kW and from 2.4 to 3.6 kW. Total nominal load of the microgrid equals 62.0 kW.

Existing microsources and energy storage devices are typical for rural areas and include photovoltaic systems (PVs), wind-turbine generator sets (WTs), an internal combustion

reciprocating engine with synchronous generator (RE) and battery energy storage (BES). Parameters of installed microsources and energy storage device are presented in Table 1.

Table 1
Parameters of microsources and energy storage device installed in a typical countryside test microgrid

Device type	S_n [kVA]	C [kWh]	P_{max} [kW]	$\cos(\varphi)$
RE	61.0	–	49.0	0.8
PV1	4.0	–	4.0	1.0
PV2	6.0	–	6.0	1.0
PV3	10.0	–	10.0	1.0
PV4	10.0	–	10.0	1.0
WT1	2.0	–	2.0	1.0
WT2	3.0	–	3.0	1.0
WT3	5.0	–	5.0	1.0
BES	20.0	80.0	20.0	1.0

where: S_n is the nominal apparent power, C is the capacity, P_{max} is the maximum active power and $\cos(\varphi)$ is the power factor

The test microgrid is connected to the DSO grid via a 63 kVA MV/LV transformer and MV overhead line (AFL-6 35 mm² type).

The second test case was a microgrid located in a neighborhood consisting of households (see Fig. 2). This microgrid consists of 6 overhead, 4×AL 70 mm² type, and 2 cable, YAKY 4×70 mm² type, LV power lines. Lengths of LV power lines vary from 70 to 470 meters.

The microgrid contains 148 loads (mostly households, but there are also a few public utility buildings (PUBs) and 1 small industry (SI) load). Active power peak loads vary from 1.8 to 2.2 kW for households and from 2 to 10 kW for public utility buildings. Peak load of the small industry load equals 22 kW. Both the public utility buildings loads and the small industry load operate with a power factor equal to 0.93, and

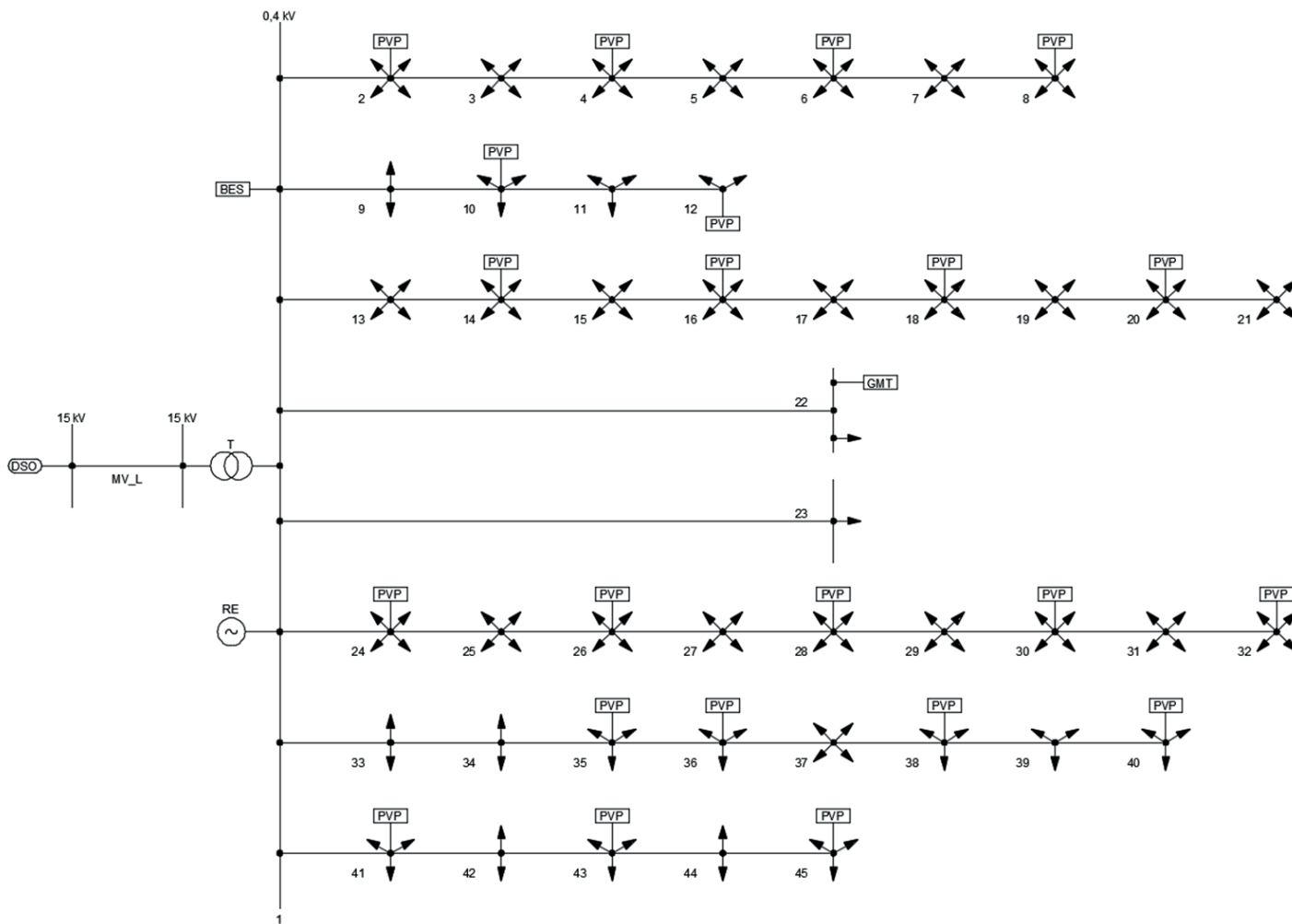

Fig. 2. Key diagram of the LV microgrid located in a neighborhood consisting of households (PVP – photovoltaic panels, BES – battery energy storage, GMT – gas microturbine, RE (SG) – reciprocating engine with internal combustion (engine-generator set))

for households the power factor equals 0.95. Total nominal load of the microgrid amounts to 340.7 kW. All public utility buildings loads and the small industry load are controllable, and the ranges of active power regulation are presented in Fig. 3.

This microgrid was equipped with 22 PVs, an RE, gas microturbine (GMT) and BES. Parameters of installed micro-sources are provided in Table 2.

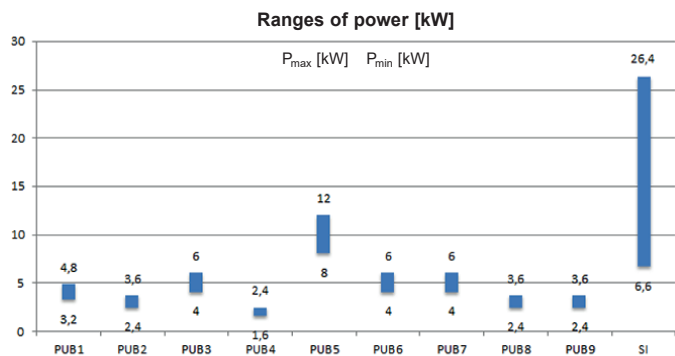

Fig. 3. Ranges of active power regulation of controllable loads for a neighborhood consisting of households test microgrid (P_{min} is the lower bound of active power adjustment, P_{max} is the upper bound of active power adjustment)

Table 2
Parameters of microsources installed in a neighborhood consisting of households test microgrid

Device type	S_n [kVA]	P_{max} [kW]	$\cos(\varphi)$
RE	250.0	200.0	0.8
GMT	31.87	30.0	0.985
PV1	4.0	4.0	1.0
PV2	5.0	5.0	1.0
PV3	4.0	4.0	1.0
PV4	4.0	4.0	1.0
PV5	3.5	3.5	1.0
PV6	8.0	8.0	1.0
PV7	4.0	4.0	1.0

Device type	S_n [kVA]	P_{max} [kW]	$\cos(\varphi)$
PV8	4.0	4.0	1.0
PV9	3.5	3.5	1.0
PV10	3.5	3.5	1.0
PV11	4.0	4.0	1.0
PV12	4.5	4.5	1.0
PV13	5.0	5.0	1.0
PV14	4.0	4.0	1.0
PV15	5.0	5.0	1.0
PV16	5.0	5.0	1.0
PV17	4.0	4.0	1.0
PV18	4.0	4.0	1.0
PV19	3.5	3.5	1.0
PV20	5.0	5.0	1.0
PV21	4.0	4.0	1.0
PV22	3.5	3.5	1.0

where: S_n is the nominal apparent power, P_{max} is the maximum active power and $\cos(\varphi)$ is the power factor

Parameters of BES are as follows:

- nominal apparent power $S_n = 80$ kVA,
- maximum active power $P_{max} = 80$ kW,
- capacity $C = 320$ kWh,
- power factor $\cos(\varphi) = 1.0$

The test microgrid is connected to the DSO grid via a 400 kVA MV/LV transformer and MV overhead line (AFL-6 35 mm² type).

Total values of the power generated in uncontrollable microsources (PVs and WTs) for both microgrids are provided in Table 3 (values are in [kW]).

Table 3
Total values of power generated in uncontrollable microsources

Location of microgrid	Summer, Wednesday, 12:00 [kW]	Winter, Wednesday, 18:00 [kW]
Typical countryside	17.413	2.71
Neighborhood consisting of households	51.3	0.0

5.2. Results of optimization calculations with the use of distributed control logic algorithm. The distributed control logic algorithm was tested only for the first test microgrid. Optimization calculations were carried out for two seasons, on a selected day of the week and at selected hours of the day:

- summer, Wednesday, 12:00,
- winter, Wednesday, 18:00.

Optimization calculations results are presented in Tables 4–7 and in Fig. 4 (Note: active power values as well as active power losses values are in [kW]).

Table 4
Set of optimization calculations results obtained for a typical countryside test microgrid operated in a synchronous mode, summer, Wednesday, 12:00 (distributed control logic)

CF No.	Result	P_{DSO}	P_L	ΔP	P_{ES}	P_{RE}	P_{UCM}
1	0.548	2.69	58.38	0.55	1.83	37.00	17.41
2	4.353	-9.55	58.32	0.60	14.06	37.00	17.41
3	5.135	7.50	56.85	0.82	20.00	12.76	17.41
4	-2.162	7.41	59.23	0.86	20.00	15.27	17.41

where: CF is the criterion function, $Result$ is the value of objective function, P_{DSO} is the active power imported/exported from/to the DSO power grid, P_L is the total active power received in nodes, ΔP is the total power losses, P_{ES} is the active power generated (consumed if value is negative) by battery energy storage, P_{RE} is the active power generated by the reciprocating engine and P_{UCM} is the total active power generated by uncontrollable microsources.

Table 5
Set of optimization calculations results obtained for a typical countryside test microgrid operated in synchronous mode, winter, Wednesday, 18:00 (distributed control logic)

CF No.	Result	P_{DSO}	P_L	ΔP	P_{ES}	P_{RE}	P_{UCM}
1	1.009	9.22	60.01	1.01	14.06	37.00	0.75
3	7.225	18.29	58.28	1.31	20.00	18.59	2.71
4	-0.205	18.24	59.63	1.34	20.00	20.02	2.71

Table 6
Set of optimization calculations results obtained for a typical countryside test microgrid operated in an island mode, summer, Wednesday, 12:00 (distributed control logic)

CF No.	Result	P_L	ΔP	P_{ES}	P_{RE}	P_{UCM}
1	0.776	56.85	0.78	14.17	26.04	17.41
2	4.353	56.85	0.78	20.00	20.22	17.41
3	5.451	56.85	0.78	20.00	20.22	17.41
4	1.940	56.85	0.78	20.00	20.22	17.41

Table 7
Set of optimization calculation results obtained for a typical countryside test microgrid operated in an island mode, winter, Wednesday, 18:00 (distributed control logic)

CF No.	Result	P_L	ΔP	P_{ES}	P_{RE}	P_{UCM}
1	1.027	60.01	1.03	14.06	46.23	0.75
3	8.137	58.28	1.24	20.00	36.80	2.71
4	-1.058	58.28	1.24	20.00	36.80	2.71

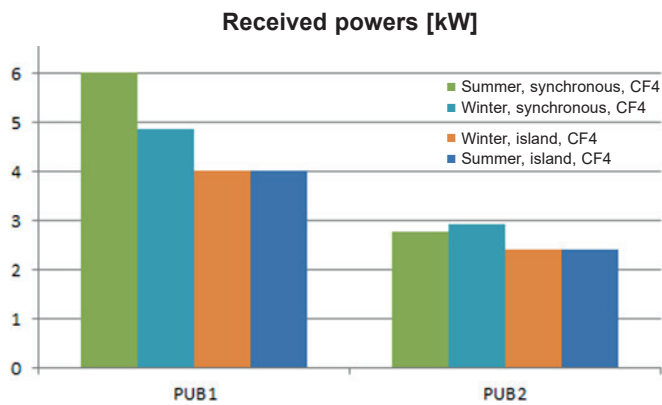

Fig. 4. Powers received by controllable loads in a typical countryside test microgrid (distributed control logic, CF4 – criterion function 4)

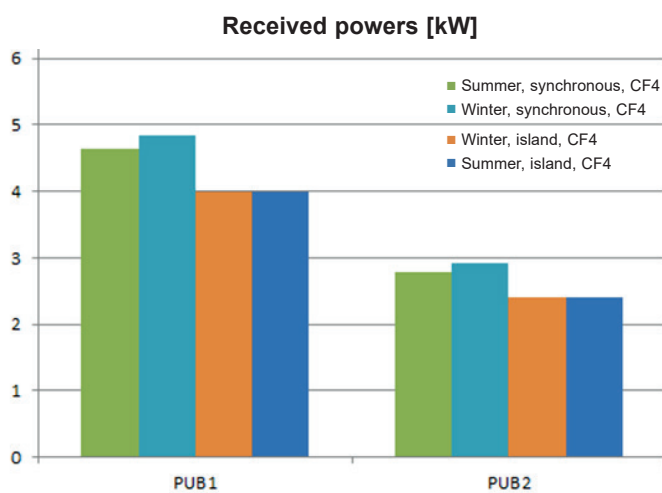

Fig. 5. Powers received by controllable loads in a typical countryside test microgrid (centralized control logic)

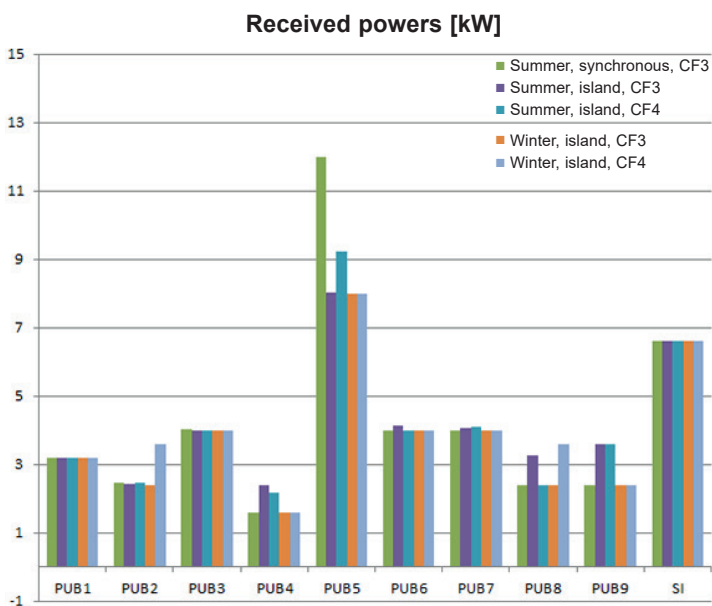

Fig. 6. Powers received by controllable loads in a neighborhood consisting of households test microgrid (centralized control logic)

5.3. Results of optimization calculations with the use of the centralized control logic algorithm. The centralized control logic algorithm was tested for both test microgrids. Optimization calculations were carried out for the same conditions as in the case of the distributed control algorithm. The results of calculations are presented in Tables 8–15 and in Fig. 5–6 (Note: as previously, active power values as well as active power losses values are in [kW]).

Table 8

Set of optimization calculations results obtained for a typical countryside test microgrid operated in a synchronous mode, summer, Wednesday, 12:00 (centralized control logic)

CF No.	Result	P_{DSO}	P_L	ΔP	P_{ES}	P_{RE}	P_{UCM}
1	0.764	3.62	56.85	0.76	10.86	25.72	17.41
2	4.353	50.80	57.84	1.71	-8.66	0.00	17.41
3	4.613	20.48	56.85	1.04	20.00	0.00	17.41
4	2.787	21.52	57.86	1.08	20.00	0.00	17.41

Table 9

Set of optimization calculations results obtained for a typical countryside test microgrid operated in a synchronous mode, winter, Wednesday, 18:00 (centralized control logic)

CF No.	Result	P_{DSO}	P_L	ΔP	P_{ES}	P_{RE}	P_{UCM}
1	1.224	6.34	58.28	1.22	19.54	30.91	2.71
3	6.339	37.35	58.28	1.78	20.00	0.00	2.71
4	0.748	38.78	59.63	1.86	20.00	0.00	2.71

Table 10

Set of optimization calculations results obtained for a typical countryside test microgrid operated in an island mode, summer, Wednesday, 12:00 (centralized control logic)

CF No.	Result	P_L	ΔP	P_{ES}	P_{RE}	P_{UCM}
1	0.776	56.85	0.78	14.14	26.07	17.41
2	4.353	58.19	0.86	-4.26	45.89	17.41
3	5.451	56.85	0.78	20.00	20.22	17.41
4	1.940	56.85	0.78	20.00	20.22	17.41

Table 11

Set of optimization calculations results obtained for a typical countryside test microgrid operated in an island mode, winter, Wednesday, 18:00 (centralized control logic)

CF No.	Result	P_L	ΔP	P_{ES}	P_{RE}	P_{UCM}
1	1.241	58.28	1.24	20.00	36.80	2.71
3	8.137	58.28	1.24	20.00	36.80	2.71
4	-1.058	58.28	1.24	20.00	36.80	2.71

Table 12

Set of optimization calculations results obtained for a neighborhood consisting of households test microgrid operated in a synchronous mode, summer, Wednesday, 12:00 (centralized control logic)

CF No.	Result	P_{DSO}	P_L	ΔP	P_{ES}	P_{RE}	P_{MTG}	P_{UCM}
1	8.031	53.88	327.15	8.03	0.00	200.00	30.00	51.30
2	12.825	234.96	313.08	9.83	22.99	0.00	13.92	51.30
3	30.216	183.42	305.51	9.27	80.00	0.00	0.06	51.30
4	10.543	175.16	327.13	9.29	79.97	0.00	30.00	51.30

Table 13

Set of optimization calculations results obtained for a neighborhood consisting of households test microgrid operated in a synchronous mode, winter, Wednesday, 18:00 (centralized control logic)

CF No.	Result	P_{DSO}	P_L	ΔP	P_{ES}	P_{RE}	P_{MTG}	P_{UCM}
1	10.797	57.50	321.88	10.80	45.18	200.00	30.00	0.00
3	35.114	211.69	309.13	12.56	80.00	0.00	30.00	0.00
4	3.015	238.90	335.78	13.12	80.00	0.00	30.00	0.00

Table 14

Set of optimization calculations results obtained for a neighborhood consisting of households test microgrid operated in an island mode, summer, Wednesday, 12:00 (centralized control logic)

CF No.	Result	P_L	ΔP	P_{ES}	P_{RE}	P_{MTG}	P_{UCM}
1	8.021	314.91	8.02	60.27	181.38	29.99	51.30
2	12.825	311.73	8.36	80.00	188.79	0.00	51.30
3	36.050	304.57	8.16	80.00	151.46	29.96	51.30
4	3.933	304.57	8.14	80.00	151.41	30.00	51.30

Table 15

Set of optimization calculations results obtained for a neighborhood consisting of households test microgrid operated in an island mode, winter, Wednesday, 18:00 (centralized control logic)

CF No.	Result	P_L	ΔP	P_{ES}	P_{RE}	P_{MTG}	P_{UCM}
1	11.012	303.93	11.01	80.00	204.95	30.00	0.00
3	44.708	303.93	11.01	80.00	204.95	30.00	0.00
4	7.513	306.33	11.04	80.00	207.38	30.00	0.00

5.4. Substantial findings. Having such a set of results at our disposal, we can analyze what the differences in the behavior of control algorithms are, when individual objective functions and calculations modes (centralized vs distributed) are applied.

In the case of focusing on maximization of the amount of energy generated by renewable energy sources (CF2), the algorithm does nothing more than setting the operating points of all the RES microsources to the maximum, if only possible (Tables 8, 10, 12 and 14).

The last three objective functions are a slightly less straightforward and, as a result, they are more difficult to analyze. In the case of minimization of active power losses (CF1), the local generation and consumption of energy is promoted. When taking a deeper look at the topology of our examples (test microgrids), the biggest losses should be observed on the branches connecting the DSO network with the microgrid, so, as a result, the algorithm needs to limit the exchange of energy between the microgrid and the network to the minimum (Tables 8, 9, 12 and 13). Apart from this, there is no clear rule on which energy sources should be prioritized and used first – this always depends strictly on the particular topology of connections. However, we can see that the algorithm always finds the variant with the smallest amount of power losses in comparison to the variants found for other criterion functions (Tables 8–11 and 12–15).

When focusing on minimization of the costs related to microgrid operation (CF3), the algorithm finds out that some energy sources are cheaper than others. The assumed structure of costs results in renewable energy sources (wind turbines and photovoltaic panels) being the cheapest ones and the reciprocating engine being the most expensive one. The energy storage, which is assumed to be charged in the periods when some excess generation levels of renewable energy sources in relation to the microgrid internal needs are to be experienced, and in the periods where the price of electricity provided by the DSO network is the lowest, can be treated as the second best solution in terms of costs. The costs of the energy bought from the DSO network and generated by the gas microturbine are assumed to be similar and the exact relation between them can depend on the particular season, day of the week and hour of the day (with the gas microturbine usually being slightly cheaper). Generally, we can observe that the algorithm obeys these rules and prioritizes cheaper energy sources over the more expensive ones (Tables 8–11 and 12–15). Renewable energy sources and energy storage are always utilized at their full generation capabilities. The reciprocating engine never works in the synchronous operation mode – it is only used in the island operation mode, when it replaces the DSO network. The power received by controllable loads is reduced to the minimum, in order to not generate any additional costs if not needed (Fig. 6).

When it comes to the maximization of profits from microgrid operation (CF4), an additional factor is considered – the price of the energy sold to the customers. It is dependent on the particular season, day of the week and hour of the day, similarly to the DSO network electricity price, but in most cases it is assumed to be a little higher than the cost of generating electricity with the use of the gas microturbine and also a little higher than the cost of purchasing energy from the DSO network. The conclusions are almost the same as in the case of an objective function related to costs. The biggest difference that can be observed in the behavior of the algorithm is the fact that it appears to be profitable to increase the amount of energy received by the customers to the possible maximum (Tables 8, 9, 12 and 13). The additional amount of energy to be generated can be acquired from the gas microturbine or from the DSO network and sold to the customers at a higher price.

The only exception here is the island operation mode. Then we are almost always in the state of deficit of energy coming from relatively cheap energy sources (RES, energy storage, gas microturbine) and forced to make use of expensive energy provided by the reciprocating engine intensively. That is why we decide to reduce the amount of energy consumed by receivers (Tables 10, 11, 14 and 15), by setting minimum operating points in controllable loads (Fig. 6), as much as possible.

Although the numbers given in the tables provide us in almost all cases with clear evidence that our findings are right, we need to remember that our presented analysis of results has so far not taken into consideration that in some particular situations certain sets of operating points cannot be applied because it could lead to violating nodal voltage constraints, exceeding overhead lines and cables long-term current-carrying capacities or overloading the transformer (such checks are performed by the algorithm every time). So, some solutions that might appear attractive or even better than the ones that were found might eventually prove infeasible. We also experienced, for instance, the situations where some amount of energy could be additionally generated and sold with a profit, but this extra transfer of energy would result in such an increase in the total power losses, that the costs could outweigh the potential incomes. Finally, the number of iterations of the algorithm is finite and can be easily increased, if needed, which in most cases would lead to obtaining more precise results. The only limitation would be the computational capabilities of the server on which the algorithm could be deployed in real world conditions.

In most cases our main findings also hold in the case of taking advantage of the approach based on distributed control logic (Tables 4–7). However, we need to remember that the behavior of our algorithm changes significantly. The PSO method is not used anymore. Instead, we treat each group of devices separately, one by one. For one particular group of devices, we propose a set of different total levels of power generation/consumption for the group treated as a whole. Such a level can be easily transformed into a combination of operating points for all the devices belonging to the group. All those combinations are evaluated one by one and then the best one is chosen. When one group is being processed, it is assumed that the operating points of the devices belonging to the other groups are previously computed, given and fixed in the current iteration. Processing all the groups one by one results in a full cycle of optimization calculations. The numbers presented in the tables are the results of only one optimization cycle. Other ones would probably yield better and more precise solutions, especially bearing in mind that groups do not cooperate with each other and some optimization possibilities (especially in the case of more complicated functions, such as CF3 or CF4) can be unlocked only if certain other groups are processed first.

5.5. General observations. The following key observations resulting from the experiments can be formulated:

1. For the synchronous operation mode for both microgrids in the case of centralized control logic:

- a) for criteria No. 3 and 4, the powers generated by battery energy storage are equal or close to its rated power;
 - b) for criteria No. 2, 3 and 4, the reciprocating engine does not work;
 - c) for all criteria, total powers generated in uncontrollable microsources (PVs and WTs) in the summer have the highest values;
 - d) for criterion No. 3, total powers received in the nodes have the smallest values;
 - e) in the case of criterion No. 1, total power losses have the smallest values;
 - f) total incomes (revenues minus costs) generated by microgrid operation (see “Result” column for criterion No. 4) in winter are smaller than the ones in the summer.
2. For the island operation mode for both microgrids in the case of centralized control logic:
 - a) for criteria No. 2, 3 and 4, all microsources and energy storage usually work;
 - b) for criteria No. 3 and 4, the total power received in the nodes is rather similar;
 - c) for criteria No. 1, 3 and 4, total power losses are rather similar;
 - d) total incomes (revenues minus costs) generated by microgrid operation (see “Result” column for criterion No. 4) in winter can be negative.
 3. For the synchronous operation mode of test microgrid No. 1 in the case of distributed control logic:
 - a) for criteria No. 3, and 4, the powers generated by battery energy storage are equal to its rated power;
 - b) for all criteria, total powers generated in uncontrollable microsources (LVs and WTs) in summer have the highest values;
 - c) in the case of criterion No. 3, total power received in the nodes has the smallest value;
 - d) in the case of criterion No. 1, total power losses have the smallest values;
 - e) the sum of total fixed and variable costs related to microgrid operation (see “Result” column for criterion No. 3) in winter is greater than the one in the summer.
 4. For the island operation mode of test microgrid No. 1 in the case of distributed control logic:
 - a) for criteria No. 2, 3 and 4, all microsources and energy storage usually work;
 - b) for criteria No. 2, 3 and 4, total powers received in the nodes and, respectively, total power losses are the same;
 - c) total incomes (revenues minus costs) generated by microgrid operation (see “Result” column for criterion No. 4) in winter can be negative.
 5. Behavior of controllable loads for centralized and distributed control logic seems to be correct. In the island operation state increasing total power received in the nodes cannot be possible because violations of constraints concerning rated powers in generating units can appear.
 6. Among all 14 considered cases for test microgrid No. 1, for 4 cases better solutions were obtained for centralized

control logic, for 3 cases better solutions were obtained for distributed control logic, and for 7 cases the solutions were the same (see Fig. 7–8).

Comparison of the results of optimization calculations for test microgrid (summer)

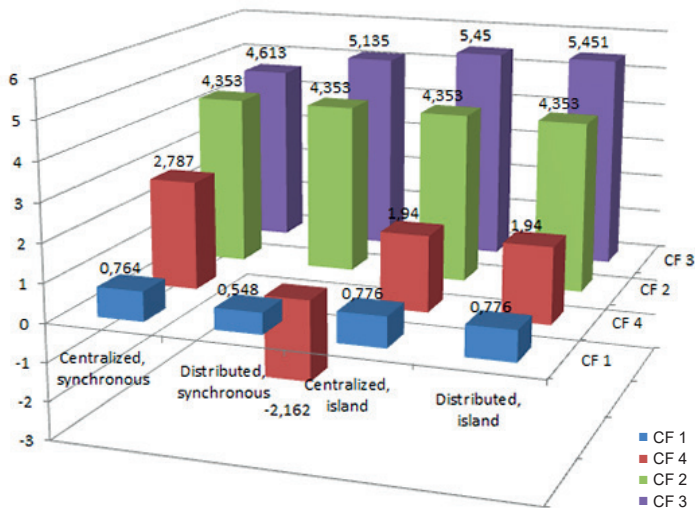

Fig. 7. Comparison of the results of optimization calculations for test microgrid obtained with the use of centralized control logic and distributed control logic (summer)

Comparison of the results of optimization calculations for test microgrid (winter)

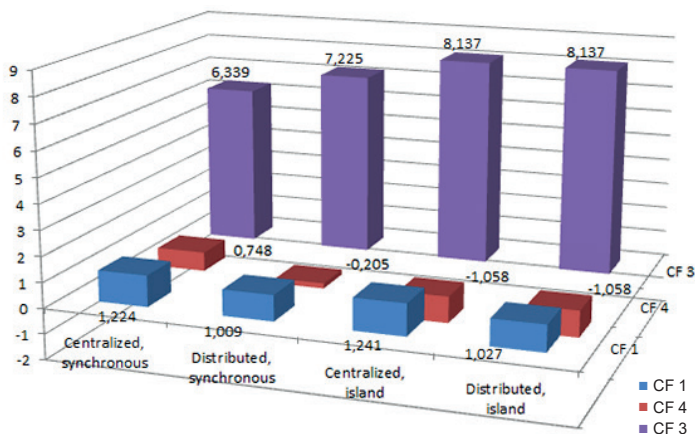

Fig. 8. Comparison of the results of optimization calculations for test microgrid obtained with the use of centralized control logic and distributed control logic (winter)

6. Summary and conclusion

The topic of optimal operation control of low voltage microgrids in rural areas has been presented in the paper. The following aspects concerning the subject of the paper: short characteristics

of LV microgrids in rural areas, formulation of the problem, description of the proposed microgrid control algorithms (based on centralized and distributed control logic), characteristics of the developed computer program as well as the description of a case study have been described in the paper in detail. The most interesting results of optimization calculations have been presented in the paper, on the basis of multiple computational experiments carried out.

As results of computations show, both types of control logic used, i.e. centralized control logic and distributed control logic, seem to be promising and effective tools for optimization of configurations and operation states in the low voltage microgrids subject to consideration. At the same time, we can see that operation of microsources, energy storage devices and controllable loads along with the economic aspects of microgrid functioning, strongly depend on the mode of microgrid operation, which can be grid-connected or islanded. When analyzing the synchronous mode of operation, the algorithm relying on centralized logic seems to work slightly better. In turn, for the island operation mode the distributed algorithm yields slightly better results. For simpler objective functions (e.g. CF1), the distributed algorithm seems to be more promising, while for more complicated ones (CF3 and CF4), the centralized version of the algorithm is a proper choice. Finally, it should be emphasized that the choice of the optimization criterion both in the case of centralized control logic and distributed control logic is an essential problem from the practical point of view. However, the choice here should be made by the person in charge of microgrid operation. Objective functions as such cannot be compared to each other because they reflect different potential motivations of microgrid operators as well as different goals they can decide to reach.

In further scientific research, special attention should be paid to optimization of configurations and operation states in low voltage microgrids with the use of distributed control logic. In particular, the impact of initial conditions, i.e. initial microgrid configuration and status as well as the order of processing particular groups of devices, on the results of optimization calculations should be studied in detail. Moreover, the influence of the issue of continuity of communication between particular groups of devices and between individual devices within the group on the possibility of carrying out the optimization process needs to be investigated.

At the same time, another very important topic is the issue of time complexity of our algorithms and optimization methods. The shorter the average period of time needed to perform calculations, the more frequently can the algorithms be invoked, which should positively impact the quality of operating points being determined for particular devices. Such an analysis of computational efficiency is definitely worth being performed in the case of our optimization approaches.

Acknowledgements. The paper was financed from the funds earmarked for the RIGRID (rural intelligent grid) project realization. The authors gratefully acknowledge funding of this research from the ERA-Net Smart Grid Plus initiative, with support from the European Union’s Horizon 2020

research and innovation program. Printing the paper was financed from the funds of the Faculty of Electrical Engineering of Warsaw University of Technology earmarked for science and research.

REFERENCES

- [1] J. Shanmugapriyan, N. Karuppiah, S. Muthubalaji, and S. Tamilselvi, "Optimum placement of multi type DG units for loss reduction in a radial distribution system considering the distributed generation suitability index using evolutionary algorithms", *Bull. Pol. Ac.: Tech.* 66(3), 345–354 (2018).
- [2] W. Marańda and M. Piotrowicz, "Efficiency of maximum power point tracking in photovoltaic system under variable solar irradiance", *Bull. Pol. Ac.: Tech.* 62(4), 713–721 (2014).
- [3] J. Kiciński, "Do we have a chance for small-scale energy generation? The examples of technologies and devices for distributed energy systems in micro & small scale in Poland", *Bull. Pol. Ac.: Tech.* 61(4), 749–756 (2013).
- [4] I. Wasiak and Z. Hanzelka, "Integration of distributed energy sources with electrical power grid", *Bull. Pol. Ac.: Tech.* 57(4), 297–309 (2009).
- [5] CIGRÉ Working Group C6.22 Microgrids evolution roadmap, Microgrids 1: Engineering, economics & experience, TB 635, 2015.
- [6] Ch. Marnay, S. Chatzivasilieiadis, Ch. Abbey, R. Iravani, G. Joos, P. Lombardi, P. Mancarella, and J. von Appen, "Microgrid evolution roadmap. Engineering, economics, and experience", *Paper presented at the 2015 Int. Symp. on Smart Electric Distribution Systems and Technologies (EDST15)*, CIGRE SC C6 Colloquium, Vienna, Austria, 8–11 September 2015.
- [7] <https://building-microgrid.lbl.gov/>. Accessed 20 Mar 2019.
- [8] Microgrids: architectures and control, ed. N.D. Hatziaargyriou, IEEE Press, Wiley, 2014.
- [9] Low voltage microgrids. Joint publication edited by Mirosław Parol, Publishing House of the Warsaw University of Technology, Warsaw, 2013, [in Polish].
- [10] R. Parol, M. Parol, and Ł. Rokicki, "Implementation issues concerning optimal operation control algorithms in low voltage microgrids", in *Pendrive Proc. of the 5th Int. Symp. on Electrical and Electronics Engineering*, Galati, Romania, 20–22 October 2017, 7 pp.
- [11] M. Parol and K. Księżyk, "Optimum control in microgrids", in *Pendrive Proc. of the Second Int. Youth Conf. on Energetics*, Budapest, Hungary, 4–6 June 2009, 6 pp.
- [12] F. Katiraei, R. Iravani, N.D. Hatziaargyriou, and A.L. Dimeas, "Microgrids management. Control and operation aspects of microgrids", *IEEE Power & Energy Mag.*, 6(3), 54–65 (2008).
- [13] F. Katiraei and R. Iravani, "Power management strategies for a microgrid with multiple distributed generation units", *IEEE Trans. Power Syst.*, 21(4), 1821–1831 (2006).
- [14] A.L. Dimeas and N.D. Hatziaargyriou, "Operation of a multiagent system for microgrid control", *IEEE Trans. Power Syst.*, 20(3), 1447–1455 (2005).
- [15] J.A. Pecos Lopes, C.L. Moreira, and A.G. Madureira, "Defining control strategies for microgrids islanded operation", *IEEE Trans. Power Syst.*, 21(2), 916–924 (2005).
- [16] M. Parol, Ł. Rokicki, M. Połecki, R. Parol, P. Komarnicki, B. Arendarski, and M. Piotrowski, "Designing and optimal control of low voltage microgrids operation in rural areas", in *Prosumment power engineering. Consolidation of social, economic and technical issues within the process of Polish electric energy market transformation*, Częstochowa, Poland, 2017, [in Polish].
- [17] M. Parol, Ł. Rokicki, and R. Parol, "Optimal operation control in low voltage microgrids in rural areas functioning on the basis of centralized control logic", *Przegląd Elektrotechniczny (Electrical Rev.)*, 94(3), 134–138, doi:10.15199/48.2018.03.26 (2018).
- [18] Y. Li and F. Nejabatkhah, "Overview of control, integration and energy management of microgrid", *J. Mod. Power Syst. Clean Energy*, 2(3), 212–222, doi:10.1007/s40565-014-0063-1 (2014).
- [19] W. Lu, Y. Zhao, W. Li, and H. Du, "Design and application of microgrid operation control system based on IEC 61850", *J. Mod. Power Syst. Clean Energy*, 2(3), 256–263, doi:10.1007/s40565-014-0074-y (2014).
- [20] H. Zhao, Q. Wu, C. Wang, L. Cheng, and C.N. Rasmussen, "Fuzzy logic based coordinated control of battery energy storage system and dispatchable distributed generation for microgrid", *J. Mod. Power Syst. Clean Energy*, 3(3), 422–428, doi:10.1007/s40565-015-0119-x (2015).
- [21] R. Jalizade Hamidi, H. Livani, S.H. Hesseinian, and G.B. Gharehpetian, "Distributed cooperative control system for smart microgrids", *Electr. Pow. Syst. Res.*, 130, 241–250 (2016).
- [22] S. Bahrami and F. Safe, "A financial approach to evaluate an optimized combined cooling, heat and power system", *Energy Power Eng.*, 5(5), 352–362 (2013).
- [23] M. Hadi Amini, K.G. Broojeni, T. Dragičević, A. Nejadpak, S.S. Iyengar, and F. Blaabjerg, "Application of cloud computing in power routing for clusters of microgrids using oblivious network routing algorithm", in *Proc. of the 19th European Conf. on Power Electronics and Applications, EPE'17 ECCE Europe*, Warsaw, Poland, September 11–14, 2017, 11 pp.
- [24] D.E. Olivares, C.A. Cañizares, and M. Kazerani, "A Centralized Energy Management System for Isolated Microgrids", *IEEE Trans. Smart Grid*, 5(4), 1864–1875 (2014).
- [25] J. Sachs and O. Sawodny, "A two-stage model predictive control strategy for economic diesel-PV-battery island microgrid operation in rural areas", *IEEE Trans. Sustainable Energy*, 7(3), 903–913 (2016).
- [26] T. Morstyn, B. Hredzak, and V.G. Agelidis, "Control strategies for microgrids with distributed energy storage systems: an overview", *IEEE Trans. Smart Grid*, 9 (4), 3652–3666 (2018).
- [27] Y. Han, K. Zhang, H. Li, E.A. Alves Coelho, and J.M. Guerrero, "MAS-based distributed coordinated control and optimization in microgrid and microgrid clusters: a comprehensive overview", *IEEE Trans. Power Electron.*, 33(8), 6488–6508 (2018).
- [28] Q. Li, C. Peng, M. Chen, F. Chen, W. Kang, J.M. Guerrero, and D. Abbott, "Networked and distributed control method with optimal power dispatch for islanded microgrids", *IEEE Trans. Ind. Electron.*, 64(1), 493–504 (2017).
- [29] Y. Levron, J.M. Guerrero, and Y. Beck, "Optimal power flow in microgrids with energy storage", *IEEE Trans. Power Syst.*, 28(3), 3226–3234 (2013).
- [30] W. Shi, N. Li, Chi-Cheng Chu, and R. Gadh, "Real-time energy management in microgrids", *IEEE Trans. Smart Grid*, 8(1), 228–238 (2017).