

On the accuracy of detailed model inductance matrix estimation for air core winding

JAFAR NOSRATIAN AHOUR, SAEED SEYEDTABAIL, GEVORK B. GHAREHPETIAN

*Faculty of Engineering
Shahed University, Tehran, Iran
e-mail: stabaii@shahed.ac.ir*

(Received: 04.02.2017, revised: 04.08.2017)

Abstract: Researchers have used various methods to determine the parameters of transformer-equivalent circuits in transient studies. But most of these previous algorithms had difficulty finding the equivalent circuit parameters in a bigger model. This paper presents a new method to extract the inductance matrix of a detailed model for an air core winding for transient studies using frequency-response measurement data. This matrix can be determined with acceptable accuracy by using the proposed method. The biggest advantage of the proposed method is a reduction in the search space, and thus, speedier problem-solving. Simulations showed that the use of the proposed method leads to better behavioural quality of a transformer winding. The simulation results of the previous and proposed methods were compared with the help of a 20/0.4 kV, 1600 kVA transformer. This comparison showed the accuracy and superiority of the proposed method.

Key words: detailed transformer model, transient, inductance matrix and homogeneous structure

1. Introduction

Power transformers are the most expensive and important equipment of substations. Finding a precise and appropriate model of a transformer is very important for transient studies. Several attempts have been made to find a proper and accurate model based on the physical structure of the transformer [1-3], the black-box modelling [4-5], and hybrid models [6]. Each of these models has its special property. The black box models are extracted based on the measured data from the main terminal of the transformer. Furthermore, using this model to consider internal fault of the transformer is impossible. Simulation process of physical models, which are based on an FEM (Finite Element Method) or considered a lot of RLC elements (so called detailed models), due to their numerous elements [7-11] is very long. In the development of these models, parameter determination is one of the most important parts [7-11]. To study internal behaviour of a transformer winding using a fast transient analysis, transformer models are based on distributed inductive, capacitive, and resistive elements.

Unfortunately, standards do not suggest any test setup to determine the model parameter other than at power frequency (50/60 Hz) [9]. Hence, three basic methodologies may be pursued by direct calculation based on analytical equations, electromagnetic field simulation and experimental circuit test. The electromagnetic field simulation and parameter calculation based on winding construction are not typically available except to transformer manufacturers. In the experimental method, a feature of a transformer such as impedance frequency response (IFR) is measured and a model is fitted to it by using an optimization method which minimizes a merit of similarity between the actual and the simulated feature [10-11].

A detailed model is one of the most well-developed power transformer models. It is based on the transformer's physical properties and dimensions [3]. Validity and accuracy of a detailed model depends on the topology of the model, the number of sections it has, and parameters of the model [8, 12-14]. When there are too many sections, the model's accuracy and validity are acceptable. But determining the appropriate value of the parameters becomes complicated. Therefore, a compromise is needed between the model's accuracy and the dimensions of the equivalent circuit. Various efforts to calculate parameters of the model have been done [7, 8, 14-19]. The analytical methods need insulation and conductor material of a transformer and its geometry data which is not available except to the transformer manufacturers. Also in transient studies, the analytical methods are not often precise and produce significant errors [8, 20-21]. In the experimental method, different algorithms have been used to estimate the parameters of transformer windings [11, 22-24]. In previous studies [11, 13, 22-23] to determine the equivalent circuit parameters, some effective recommendations have been made. When the dimensions of the equivalent circuit increase, applying these recommendations becomes difficult. Also determining the parameters of the model becomes complicated. It should be mentioned that the method, presented in [25], has developed a closed-form expression that connects the natural frequencies of a single, isolated transformer winding to its inductances and capacitances. Therefore, first of all, the inductance and capacitance matrixes of the ladder network must be identified, and then the natural frequencies of the ladder network model can be calculated. This method does not calculate the inductance matrix. In [26] a multi-objective global search for solutions is performed by means of a genetic algorithm. An important point of parameters estimation in that paper is the selection of the initial values for parameters. In other words, in that estimation method, estimating initial parameters has a key role in their method but in our proposed method, the parameter estimation is determined without using any initial estimation. In [13] and [24], the behaviour of the detailed model of a transformer winding has been discussed. In [24], a new detailed model (i.e. improved detailed model) has been presented to simulate transient behaviour of transformer winding. The test results on a 20/0.4 kV, 1600 kVA transformer indicates that the improved model is superior to the conventional one in terms of simulating the transformer transient behavior. In this paper, a major focus is on a method to find a reliable inductance matrix. In previous papers, a multi-objective search, to determine inductance matrix, has been used. Those methods are time consuming. In addition, they used several inequity constraints. The proposed method of this paper is direct and reliable one based on FRA measurement results. So in this paper, based on experimental tests, a method has been proposed to extract the inductance

matrix (self and mutual inductances) of transformer winding for transient studies. The application of the proposed model is easy, precise, and practical. This method accelerates the estimation of the inductance matrix of a detailed transformer model. Also, it increases the accuracy of finding the parameters of the detailed model.

The detailed model of the transformer winding is presented in Section 2. To find the parameters of the detailed model of the studied transformer, a parameter-estimation method is used. In Section 3, to achieve an appropriate model and reduce the optimization time, an efficient method has been proposed. In Section 4, the simulation results have been specified and they have been compared with the measurement results. In Section 5, the summary of findings has been discussed.

2. The detailed model of transformer winding

In the detailed model, the elements are physically projected. It can particularly exhibit the transformer-winding transient behaviour. Fig. 1b shows the complete detailed model [13, 24] of test setup. Each fraction of the lump model includes the numbers of turns in the winding. Therefore, each winding is modelled by a limited number of sections. Each fraction involves the series and parallel capacitances (C_s and C_g), self and mutual inductances (L and $M_{i,j}$), series and parallel resistances related to insulation losses (R_p and R_g), and ohmic resistance related to the winding (r). The complete detailed model has extra-dispersed capacitors (C_d) embedded among the sections [24], as shown in Fig. 1b.

3. Determining the inductance matrix of transformer winding

3.1. Analytical method

The parameters of a detailed model of a transformer can be determined using the finite element method (FEM), explicit formulas or estimation methods. To determine the parameters using FEM or formulas, the dimensions of the transformer are required [24]. The detailed model parameters can be determined using analytical equations [15] such as (1) to calculate mutual inductance between turns A and B in Fig. 2 as follows:

$$m_{A,B} = \frac{2\mu_0}{k'} \times \sqrt{R_A R_B} [K(k') - E(k')] \quad , \quad k' = \frac{1 - \sqrt{1 - k^2}}{1 + \sqrt{1 - k^2}} \quad , \quad k = \frac{\sqrt{4R_A R_B}}{\sqrt{(R_A + R_B)^2 + Z^2}} \quad , \quad (1)$$

where: $K(k')$ and $E(k')$ are the first and second complete elliptical integrations.

Detailed assessments [8], [20-21] indicate that common analytical relations contain significant errors (at least 20% error) and are not reliable; thus, the use of this method is not recommended.



(a)

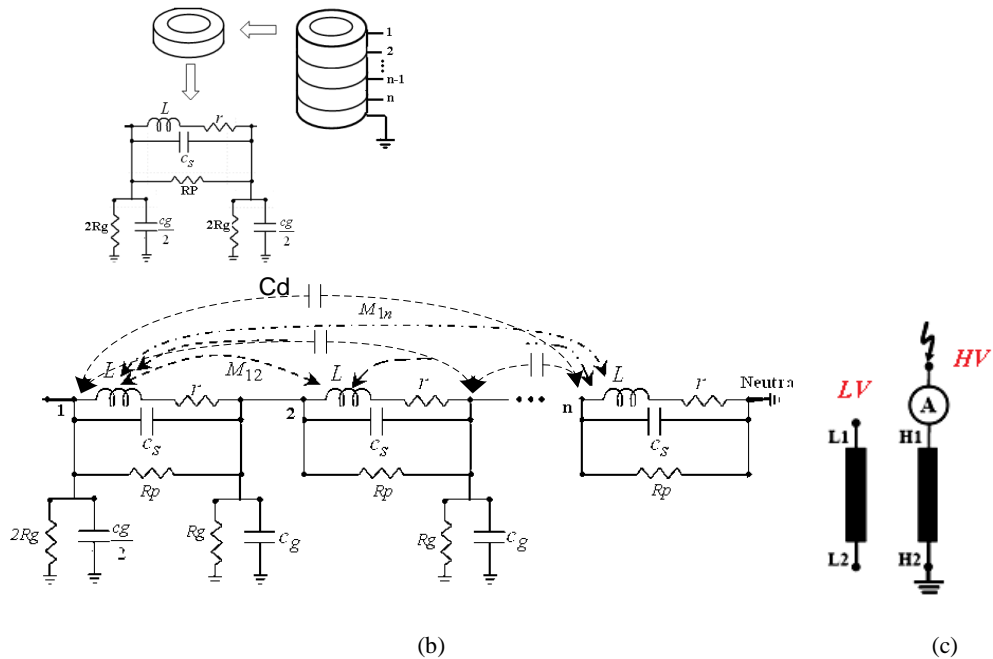

Fig. 1. Test setup and its complete detail model: (a) test setup; (b) the complete detailed model; (c) the terminal configuration of winding

3.2. Proposed method

To determine the parameters of a detailed model, estimation methods can be effective approaches. In a parameter estimation method, one feature of the transformer terminal is measured and attempts are made to determine the other parameters such that the error function between simulation and measurement results is minimized [13, 23-24]. Nosratiyan, et al. [24] offered tips based on physical insights about the transformer. To obtain an acceptable model, it is important to use relations and constraints that take logical relationships between the para-

meters of the equivalent circuits into account. Some of these constraints have been explained [13, 24]. These constraints help remove unreal equivalent circuits.

A. Structure of inductance matrix

The parameter estimation is very complex for heterogeneous models [24]. Therefore, previous studies recommended a homogenous model [11, 13, 22-24]. Suppose a winding has N turns, in which L_{11} is the self-inductance of the first turn and $m_{1,2}, m_{1,3}, \dots, m_{1,n}$ inductances describe the coupling between the first turn and other turns, as given in (2).

$$l = [L_{11} \ m_{1,2} \ m_{1,3} \ \dots \ m_{1,n}]. \quad (2)$$

If the winding structure is supposed to be homogeneous, the inductance matrix can be written as (3):

$$L = \begin{bmatrix} L_{1,1} & m_{1,2} & m_{1,3} & \dots & m_{1,n} \\ m_{1,2} & L_{1,1} & m_{1,2} & \dots & m_{1,n-1} \\ m_{1,3} & m_{1,2} & L_{1,1} & \dots & m_{1,n-2} \\ \cdot & \cdot & \cdot & \cdot & \cdot \\ \cdot & \cdot & \cdot & \cdot & \cdot \\ m_{1,n} & m_{1,n-1} & m_{1,n-2} & \dots & L_{1,1} \end{bmatrix}. \quad (3)$$

Considering the structure of a transformer winding, the coupling between the turns must follow specific rules. In the previous studies [11, 13, 24], the following inequalities were used:

$$\begin{aligned} 0.4L_{i,j} < m_{i,j+1} < 0.85L_{i,j}, \\ 0.5m_{i,j-1} < m_{i,j} < 0.95m_{i,j-1}, \\ \forall i = 1, 2, \dots, N-1, \forall j = 2, 3, \dots, N-1, \\ (m_{ij} - m_{ik}) > (m_{ik} - m_{in}) \text{ If } |i-j| > |i-k| > |i-n|. \end{aligned} \quad (4)$$

Inequalities (4) eliminate unrealistic responses and ensure that the determined structure is based on a real transformer model. To reduce the optimization procedure time and the problem search space, using the equivalent inductance criteria of [11], given by (5), is recommended.

$$L_{eq} = N_{\text{ladder}} \times L_{11} + 2 \times \sum_{i=1}^{N_{\text{ladder}}-1} (N_{\text{ladder}} - i) \times m_{1,i+1} \quad (5)$$

where: L_{eq} is the equivalent inductance of winding at power frequency, N_{ladder} is the number of sections in the equivalent circuit, L_{11} is the self-inductance at power frequency, $m_{1,i+1}$ is the mutual inductance at power frequency.

These recommendations are useful and effective in determining the correct structure of the inductance matrix. However, they do not provide a specific policy to determine self and mutual inductances. For example, different combinations (solutions) can be found to satisfy in-

equalities (4) and Equation (5). On the other hand, an increase in the dimensions of the equivalent circuit increases the number of inequalities (4). So, the state space representation of the problem [24] becomes more complicated.

B. Structure of capacitance matrix

Consider a winding with N sections, in which $C_{d_{1,2}}$ represents the capacitance between Sections 1 and 2 in Fig. 1b, $C_{d_{1,3}}$ represents the capacitance between Sections 1 and 3, and so on. From the point of symmetry, $C_{d_{1,2}} = C_{d_{2,3}} = C_{d_{3,4}}, \dots$ etc. Considering the transformer winding, the capacitances have to follow special rules so that the obtained model would be acceptable:

$$C_{d_{i,j}} > C_{d_{m,p}} \quad \text{if } |i-j| < |p-m|. \quad (6)$$

C. Rest of the parameters

The rest of the parameters of the model, such as r, R_p, R_g, \dots , are assumed to be identical in all sections [24].

D. Introducing proposed method by experimental results

Different algorithms have been presented to estimate the parameters of transformer windings [11, 22-23]. To achieve a realistic model of a transformer winding, self and mutual inductances must satisfy constraints in (4) and (5). In [23], a pseudo-code was used. It involved complex rules to estimate each of the self and mutual inductances. With that method, it will be possible to obtain parameters in the limited search space. If the dimensions of the equivalent circuit enlarge, the problem-solving time will be longer, and in some practical cases, it will become impossible. Also, another of its limitations is the parameter-estimation method. In [23], it is supposed that each parameter varies within defined bounds. The step deviation of each parameter is fixed. So, making a small adjustment in the step deviation of parameters needs a long time. The large amount of changes makes the achievement of a proper response uncertain. The used genetic algorithm in [13] may remain at a local optimum and not get the proper response. Another problem in determining the appropriate model is that the solution is not unique [11, 22-23]. As given in (4), self-inductance is bigger than mutual inductance. By increasing the distance between sections in Fig. 1b, the mutual inductance becomes smaller. Different linear and nonlinear relations can then express the relationship between self-inductance and other inductances. Fig. 3 shows the linear and nonlinear ones. The input impedance of a transformer winding, as shown in Fig. 1a, has been measured at the main terminal and the different internal nodes ($Z_{eq-i}, i=1, 2, \dots, n$). The measurements have been done with an open-circuited LV winding. In Table 1, the magnitude of the measured impedances from the different points in 5 kHz frequency (f_0) has been presented.

Table 1. The magnitude of the measured impedances from the different points in 5 kHz frequency

$Z_{eq-1} (\Omega)$	$Z_{eq-2} (\Omega)$	$Z_{eq-10} (\Omega)$	$Z_{eq-18} (\Omega)$	$Z_{eq-19} (\Omega)$
1933.33	1853.73	821.52	58.74	16.66

Here, Z_{eq-1} was measured from node 1 in Fig. 1b, etc.

In this paper, the high-voltage winding of the test setup had 19 double discs. So, a detailed model with 19 sections is selected. After measuring the impedances from the internal points, the parameters of the model can be calculated as follows:

Step 1: The calculation of L_{11} ; L_{11} can be directly calculated by using the measured impedance from the internal point 19 (Z_{eq-19}) because, as shown in Fig. 1b, it has been built only by L_{11} .

$$L_{eq-19} = \frac{Z_{eq-19}}{2 \times \pi \times f_0} \Rightarrow L_{11} = L_{eq-19}.$$

Step 2: the calculation of $m_{1,2}$; after determining L_{11} , $m_{1,2}$ can be calculated by using the measured impedance from internal point 18 (Z_{eq-18}), as shown in Fig. 1b. With homogeneous assumption of an inductance matrix of the transformer winding, Z_{eq-18} is composed of L_{11} and $m_{1,2}$.

$$L_{eq-18} = \frac{Z_{eq-18}}{2 \times \pi \times f_0} \Rightarrow L_{eq-18} = 2 \times L_{11} + 2 \times m_{1,2} \Rightarrow m_{1,2} = \frac{L_{eq-18} - 2 \times L_{11}}{2}.$$

The other steps have been calculated as shown above.

After applying the above method on the internal measured impedance of the test setup, it is found that the relationship between the self and the mutual inductances is approximately the same:

$$\begin{aligned} m_{1,2} &\cong \gamma \times L_{11} & m_{1,2} &= \gamma \times L_{11} \\ m_{1,3} &\cong \gamma \times m_{1,2} & \Rightarrow m_{1,3} &\cong \gamma^2 \times L_{11} \\ m_{1,4} &\cong \gamma \times m_{1,3} & m_{1,4} &\cong \gamma^3 \times L_{11} \end{aligned} \quad (7)$$

Here, γ is less than 1. Inserting (7) in (5) renders,

$$L_{eq} \cong L_{11} (N_{\text{ladder}} + 2 \times \sum_{i=1}^{N_{\text{ladder}}-1} (N_{\text{ladder}} - i) \times \gamma^i). \quad (8)$$

Subsequently, L_{11} is determined as follows:

$$L_{11} \cong \frac{L_{eq}}{(N_{\text{ladder}} + 2 \times \sum_{i=1}^{N_{\text{ladder}}-1} (N_{\text{ladder}} - i) \times \gamma^i)}. \quad (9)$$

In (9), L_{11} can be calculated by estimating γ (using the search method or the genetic algorithm or other algorithms). Then, by substituting it in (7), other mutual inductances can be determined more quickly. So, for the different values of γ , the different matrices may be determined. All of them satisfy winding equivalent inductance criteria from its terminal view. Among the various combinations of the inductance matrix, which one is a valid model?

In the studied air core winding, it is possible to gain access to the winding discs (as shown in Fig. 1). So, an equivalent inductance is measured from the internal point 2. It is named L'_{eq} .

In other words, in measuring L'_{eq} , a disc is removed from the winding. From among the above-mentioned matrices, all of which meet L_{eq} criteria, the matrix that satisfies L'_{eq} criteria from the internal point 2 is the accrued matrix of the transformer winding. Using the above method, the equivalent matrix of the transformer winding can be determined by two measurements [11, 13, 22-23]. The most important advantage of the proposed method is the reduction in search space and, thus, convergence. The results of this method can be used as the starting point of optimization algorithms, such as the genetic algorithm.

4. Case studies

4.1. Tested system

In this paper, tests are performed on a 20/0.4 kV transformer with a nominal power of 1600 kVA. As shown in Fig. 1a, the high-voltage winding has 19 double discs. Each of them contains 20 or 21 turns. The parameters of the transformer winding are presented in Table 2.

Table 2. The studied transformer parameters

LV winding	27 turns, 2 layers, radial width = 13 mm, height = 536 mm, $Di = 186$ mm, $Do = 212$ mm, 3 axial parallel conductors of dim. 11.8×3.35 mm with 0.5 mm paper cover double side
HV winding	780 turns, 19 double disks, radial width = 55.5mm for 20 turn disks & 58 mm for 21 turn disks, height = 494 mm, $Di = 237$ mm, $Do = 353$ mm, 1 conductor of 8.5×2.12 mm

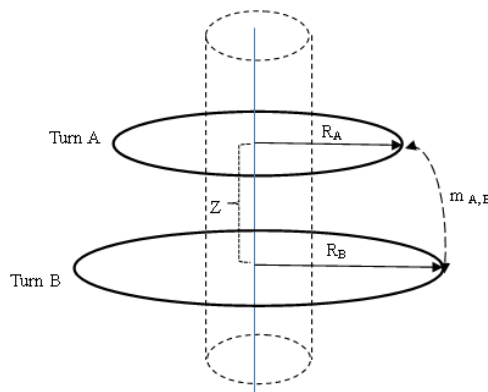

Fig. 2. Mutual inductance between turns A and B

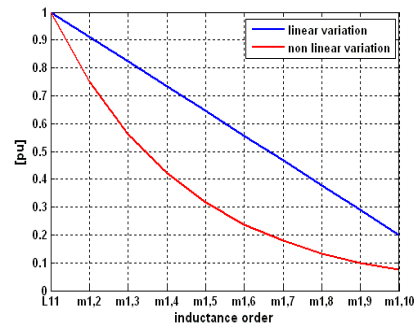

Fig. 3. Relationship between self-inductance and mutual inductances

4.2. Simulation result of the conventional method

In this paper, the input impedance of the studied transformer in the frequency domain was measured on a high-voltage terminal when the low-voltage winding was an open circuit. An impedance analyser [13] was used to measure the impedance frequency response (IFR) as a transfer function. The influences of measurement parameters and terminal configurations have been presented in [27-29]. The results of these measurements have been shown in Fig. 4.

The HV winding of the studied transformer has 19 double discs. It also has an air core. In this paper, each double disc was selected as a section of the equivalent circuit. Thus, the transformer winding was modelled by a two-winding detailed model [12]. Each winding was modelled by 19 sections, as shown in Fig. 1b. The object of modelling was to build an equivalent representation of an actual transformer winding based on data measured at input terminals. An actual winding has distributed capacitors, inductance, and resistances. But in modelling, it is mapped on to lumped parameters of a detailed model.

One of the most common methods of estimating the parameters of an equivalent circuit of a transformer is based on minimizing the difference between the reference curve (Z_m) obtained from the measurement and the simulation results (Z_e) based on the detailed model of the equivalent circuit [13]. Based on the parameters of the detailed model assigned by GA, its transfer functions and, subsequently, its frequency response is calculated, Z_e . The frequency response is compared with the measure FRA, Z_m . Then, the error function between the two graphs are calculated as follows:

$$EF = \frac{1}{N} \sum_{i=1}^N \frac{|z_{m-i} - z_{e-i}|}{z_{m-i}} \quad (10)$$

Here, N is the number of selected samples of the curve. The error function (EF) shows the estimation accuracy of the optimization method.

In this section, the inductance matrix is determined using conventional methods [11, 13, 22-23]. Considering the constraints mentioned in (4) and (5), the error function [13] is defined as (10) and is used to find the parameters of the equivalent of the 19-section circuit model. The simulation results of the conventional methods have been demonstrated in Fig. 4.

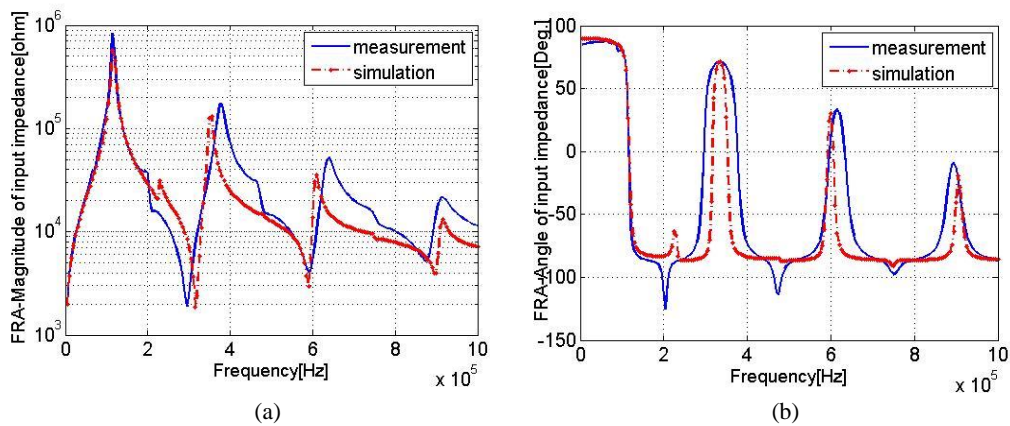

Fig 4. The measured and the estimated input impedance using the conventional method: (a) amplitude); (b) phase

Although the equivalent circuits have been extracted accurately in a limited search space due to the small dimensions of the detailed model [11, 13, 22-23], Fig. 4 shows that because of the increasing search space, the differences between the simulation and the measurement re-

sults are significant. Therefore, when the search space was widened using conventional methods [13], it was not possible to access the optimum values for the parameters of an equivalent circuit. Thus, it must be improved.

4.3. Simulation result of proposed method

Based on the data measured at the input terminal and using the introduced method in Section 3.2, the initial estimations for self and mutual inductances of the studied high-voltage transformer winding were extracted. The calculated results are shown in real and per-unit values in Fig. 5. After the calculation of the inductance matrix from the data measured at the input terminal, it was used as the starting point of the GA to estimate the inductance matrix. The rest of the parameters of the detailed model were estimated based on the recommendations in [11, 13, 22-24]. The simulation results of the proposed method were compared with the measurements in Fig. 6.

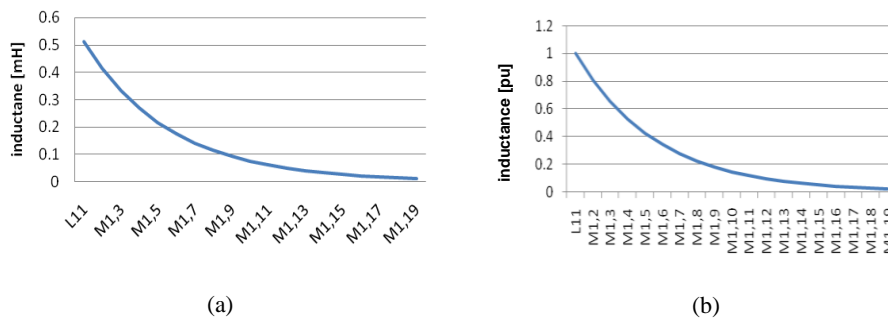

Fig. 5. Self and mutual inductance of high-voltage windings in real and per-unit values: (a) real result; (b) per unit result

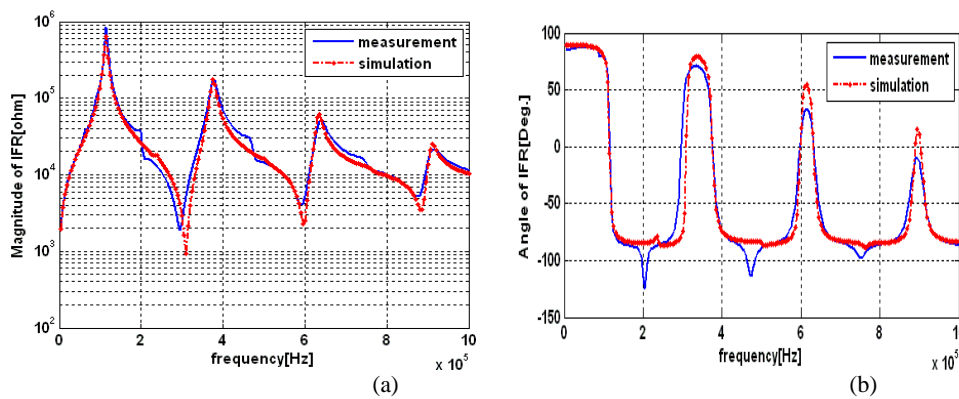

Fig. 6. The measured and the estimated (across terminal 1) input impedance using the proposed method: (a) amplitude; (b) phase

The comparison of Figs. 4 and 6 shows that the starting point of the GA plays an important role in finding the accurate parameters of a mode. Also, it shows the superiority of the proposed method. The convergence of the optimization process of the proposed and the conven-

tional methods [13] has been shown in Fig. 7. This comparison shows the accuracy and the superiority of the proposed method. By investigating Figs. 4 to 7, it can be observed that the proposed method is effective in achieving the optimum response. The proposed method can be observed to accelerate the process of estimating the inductance matrix and provide the possibility of large-scale detailed model assessment. It also reduces the complexity of the equivalent circuit parameter estimations.

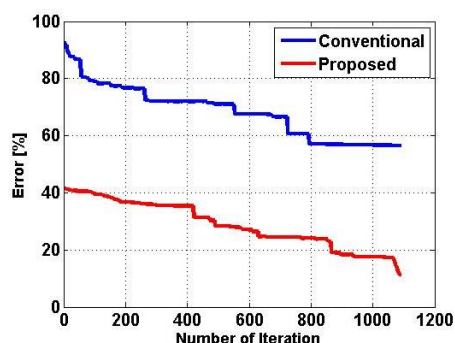

Fig. 7. The convergence of the proposed and the conventional methods in the optimization process

5. Conclusion

Based on the measured data, the mapping between the synthesized circuit and the actual transformer winding was established. This paper presents a fast and convenient method to extract the inductance matrix of a transformer-equivalent circuit. Previous algorithms faced some difficulty in finding the equivalent circuit parameters when their dimensions grew.

Conventional methods fail to attain the optimum values of the parameters of the equivalent circuit when the search space is wide. But, the technique proposed in this paper could determine with acceptable accuracy the inductance matrix of a relatively large-scale equivalent circuit. The results of this method can be used as a starting point for the optimization algorithms. The most important advantage of the proposed method is the reduction in the search space of problem-solving. Thus, it increases the speed of the problem-solving process.

References

- [1] Rashtchi V., Rahimpour E., Rezapour E., *Using a genetic algorithm for parameter identification of transformer R-L-C-M model*, ELECTR ENG, vol. 88, no. 5, pp. 417-422 (2006).
- [2] Bjerkan E., *High frequency modeling of power transformers*. Doctoral Thesis, Trondheim (2005).
- [3] Hosseini S.M.H., Enjavi Madar S.M., Vakilian M., *Using the finite element method to calculate parameters for a detailed model of transformer winding for partial discharge research*, Turk. J. Elec. Eng. & Comp. Sci., vol. 23, pp. 709-718 (2015).
- [4] Arturi C., *Transient simulation and analysis of a three phase five-limb step-up transformer following an out-of-phase synchronization*, IEEE Trans. Power Del., vol. 6, no. 1, pp. 196-207 (1991).
- [5] Vaessen P., *Transformer model for high frequencies*, IEEE Trans. Power Del., vol. 3, no. 4, pp. 1761-1768 (1988).

- [6] Morched A., Marti L., Ottewangers J., *A high frequency transformer model for the EMTP*, IEEE Trans. on Power Delivery, vol. 8, no. 3, pp. 1615-1626 (1993).
- [7] Bigdeli M., Vakilian M., Rahimpour E., Azizian D., *Theoretical and Experimental Investigation of Transformer Winding Fault Detection Using Comparison of Transfer Function Coefficients*, ECTI Trans. on electrical eng., electronics and communications, vol. 10, no. 1, pp. 10-16 (2012).
- [8] Gómez P., deLeón F., Espino-Cortés F.P., *Improved Computation of Core Inductance for Fast Transient Analysis of Transformers*, IEEE Trans. on Power Delivery, vol. 29, no. 4, pp. 2034-2036 (2014).
- [9] Martínez-Velasco J.A., *Power System Transients Parameter Determination*, CRC Press, by Taylor and Francis Group, LLC (2010).
- [10] Karimifard P., Gharehpetian G.B., Ghanizadeh A.J., Tenbohlen S., *Estimation of simulated transfer function to discriminate axial displacement and radial deformation of transformer winding*, COMPEL: Int. J. Comput. Math. Elect. Electron. Eng., vol. 31, no. 4, pp. 1277-1292 (2012).
- [11] Mukherjee P., Satish L., *Construction of Equivalent Circuit of a Single and Isolated Transformer Winding from FRA Data Using the ABC Algorithm*, IEEE Trans. on Power Delivery, vol. 27, no. 2, pp. 963-970 (2012).
- [12] Gharehpetian G.B., Mohseni H., Moller K., *Hybrid modeling of inhomogeneous transformer windings for very fast transient over voltage studies*, IEEE Trans. on Power Delivery, vol. 13, no. 1, pp. 157-163 (1998).
- [13] Shabestary M.M., Ghanizadeh A.J., Gharehpetian G.B., Agha-Mirsalim M., *Ladder Network Parameters Determination Considering Non-dominant Resonances of the Transformer Winding*, IEEE Transactions on Power Delivery, vol. 29, no. 1, pp. 108-117 (2014).
- [14] Lambert M., Martínez-Duró M., Mahseredjian J., de León F., Sirois F., *Transformer Leakage Flux Models for Electromagnetic Transients: Critical Review and Validation of a New Model*, IEEE Transaction on Power Delivery, vol. 29, no. 5, pp. 2180-2188 (2014).
- [15] Rahimpour E., Christian J., Feser K., Mohseni H., *Transfer Function Method to Diagnose Axial Displacement and Radial Deformation of Transformer Windings*, IEEE Transactions on Power Delivery, vol. 18, no. 2, pp. 493-505 (2013).
- [16] Bigdeli M., Azizian D., Bakhshi H., Rahimpour E., *Identification of transient model parameters of transformer using genetic algorithm*, International Conference on Power System Technology (POWERCON), Zhejiang, China, pp. 1-6 (2010).
- [17] Lopez-Fernandez X.M., Alvarez-Marino C., *Computation Method for Transients in Power Transformers with Lossy Windings*, IEEE Trans. on Magnetics, vol. 45, no. 3, pp. 1863-1866 (2009).
- [18] Paul C.R., *Inductance Loop and Partial*, published by John Wiley & Sons Inc., Hoboken, New Jersey (2010).
- [19] Álvarez-Mariño C., de León F., López-Fernández X.M., *Equivalent Circuit for the Leakage Inductance of Multiwinding Transformers: Unification of Terminal and Duality Models*, IEEE Transactions on Power Delivery, vol. 27, no. 1, pp. 353-361 (2012).
- [20] Gómez P., de León F., *Accurate and efficient computation of the inductance matrix of transformer winding for the simulation of very fast transients*, IEEE Transactions on Power Delivery, vol. 26, no. 3, pp. 1423-1431 (2011).
- [21] Dalessandro L., Cavalcante F.D.S., Kolar J.W., *Self-Capacitance of High-Voltage Transformers*, IEEE Transactions on Power Electronics, vol. 22, no. 5, pp. 2081-2092 (2007).
- [22] Shintemirov A., Tang W.H., Lu Z., Wu Q.H., *Simplified transformer winding modeling and parameter identification using particle swarm optimizer with passive congregation*, EvoWorkshops 2007, LNCS 4448, pp. 145-152 (2007).
- [23] Satish L., Sahoo S.K., *Locating faults in a transformer winding: An experimental study*, ELSEVIER, vol. 79, no. 1, pp. 89-97 (2009).
- [24] Ahour N.J., Seyedtabaïi S., Gharehpetian G.B., *Modified transformer winding ladder network model to assess non-dominant frequencies*, IET Electric Power Applications, vol. 11, no. 4, pp. 578-585 (2017).
- [25] Mukherjee P., Satish L., *Generalized Analytical Expression for Natural Frequencies of a Completely Inhomogeneous Transformer Winding*, IEEE Transactions on Power Delivery, IEEE Early Access Articles (2016), DOI: 10.1109/TPWRD.2016.2613119

- [26] Gómez H.D., Mombello E.E., *New Global Parameter Estimation Method for a Transformer Detailed Model*, 2014 IEEE PES Transmission & Distribution Conference and Exposition – Latin America (PES T&D-LA), pp. 1-6 (2014).
- [27] Sano T., Miyagi K., *Influence of measurement parameters on FRA characteristics of power transformers*, International Conference on Condition Monitoring and Diagnosis, CMD2008, Beijing, China, pp. 968-973 (2008).
- [28] Banszak S., *Sensitivity of transformer frequency response measurements to connection configuration*, PAK, vol. 59, no 2, pp. 164-167 (2013).
- [29] Satish L., Saravanakumar A., *Identification of Terminal Connection and System Function for Sensitive Frequency Response Measurement on Transformers*, IEEE Transactions on Power Delivery, vol. 23, no. 2, pp. 742-750 (2008).